

WPA60 Series

60 Watt Dual Output Quarter Brick DC/DC Converter

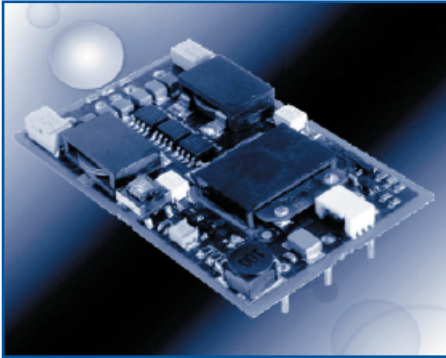

- 2.3" x 1.45" x 0.40"
(58.42mm x 36.83mm x 10.16mm)
- Dual Outputs - Output 1/Output 2 Vdc:
1.5/1.0; 1.8/1.2; 2.2/1.5; 2.5/1.8;
3.3/1.2; 3.3/1.8; 3.3/2.5; 5.0/1.5;
5.0/3.3
- Through Hole and SMT Models
- Independently Regulated Outputs
- 36V - 75V Input Range
- Industry Standard Pinouts
- Input & Output Filtering
- Remote On/Off Function
- Meets Basic Insulation Requirements of EN60950
- UL/CUL 60950, VDE EN60950 Approved
- Fixed Frequency Operation
- No Minimum Load Requirements
- Output Short Circuit Protection
- Self-resetting Over Voltage Protection
- C&D Technologies, Power Electronics Division is ISO9001:2000 Certified

The WPA60 Series are high performance DC/DC converters providing two independent regulated outputs. For maximum flexibility, power can be traded between outputs as required. The unit delivers high performance across all line and load conditions.

The WPA60 Series are assembled by a fully automated process using surface mount components for increased

reliability.

WPA DC-DC converter modules are certified to UL/CUL 60950, and VDE to EN60950. It is designed to meet CISPR22/EN55022/FCC15J Class B specs for EMI levels with external filtering.

Other features include:

- Full Regulation Down to Zero Load
- Undervoltage Lock-Out

- Auto-Start
- Internal Temperature Shutdown
- Auto-Reset
- Soft Start
- Remote On/Off (Available in Positive or Negative Logic)
- Short Circuit Protection
- Overvoltage Protection
- Output Voltage Adjust on Both Outputs

PRODUCT SELECTION CHART ¹

MODEL	NOMINAL INPUT VOLTAGE (Vdc)	OUTPUT #1	OUTPUT #2	OUTPUT CURRENT		TYPICAL EFFICIENCY (%)
				MIN LOAD(A)	MAX LOAD (A)	
WPA60R48D1510*	48	1.5	1.0	0.0	12.0 ²	82
WPA60R48D1812*	48	1.8	1.2	0.0	12.0	82
WPA60R48D2215*	48	2.2	1.5	0.0	12.0	86
WPA60R48D2518*	48	2.5	1.8	0.0	12.0	86
WPA60R48D3312*	48	3.3	1.2	0.0	12.0	89
WPA60R48D3318*	48	3.3	1.8	0.0	12.0	89
WPA60R48D3325*	48	3.3	2.5	0.0	12.0	89
WPA60R48D0515*	48	5.0	1.5	0.0	12.0	89
WPA60R48D0533*	48	5.0	3.3	0.0	12.0	90

Input current at nominal input line = 1.45A (Output Power = 60W)

*Models available with -1 option (positive logic)

¹Total output power not to exceed 60 Watts

²When the input voltage is less than 42 VDC the maximum allowable current on each output of the WPA60R48D1510 is 6A.

SPECIFICATIONS, ALL MODELS

Specifications are at $T_A = +25^\circ\text{C}$, Airflow = 300LFM (1.5m/s) at nominal input voltage unless otherwise specified.

	PARAMETER	CONDITIONS	MIN	TYP	MAX	UNITS
INPUT	INPUT					
	Voltage Range	$V_{in} = 48\text{V}$, $I_o = I$ Rated	36	48	75	VDC
	Reflected Ripple Current				675	mApk-pk
	INPUT CONTROL					
	Temperature Shutdown	PCB		120		$^\circ\text{C}$
	Temperature Hysteresis			5		$^\circ\text{C}$
	Quiescent Standby Current	$V_{in} = 48\text{VDC}$		8	10	mA
	Undervoltage Lockout			32.5		V
	Undervoltage Shutdown			2		V

SPECIFICATIONS

Specifications are at $T_A = +25^\circ\text{C}$, Airflow = 300LFM (1.5m/s) at nominal input voltage unless otherwise specified.

	PARAMETER	CONDITIONS	MIN	TYP	MAX	UNITS
GENERAL	ISOLATION					
	Rated Voltage		2000			VDC
	Resistance			10		$\text{M}\Omega$
	Capacitance			1000		pF
	Leakage Current	240 VAC		90		μArms
	OUTPUT					
	Rated Power				60	W
	Voltage Setpoint Accuracy				± 1.5	%
	Temperature Coefficient				± 0.005	$\%/^\circ\text{C}$
	Output Voltage (Over all conditions of I/P voltage load & temperature)	V1 V2			2 8	% of Nom % of Nom
	Ripple & Noise (Note 1)	BW = 5Hz to 20MHz			90	mVp-p
	Output Adjust Range Trim Up				8	%
	Trim Down				5	%
	Max Capacitive Load				10,000	μF
	Overvoltage Protection				15	%
	GENERAL					
	Switching Frequency				350	KHz
	MTTF per ML-HDBK-217 Ground Benign	Circuit Stress Method $T_A = +25^\circ$ Unmodified Database			1,000,000	Hr
	Package Weight				30	g
	TEMPERATURE					
	Operation/Specification	PCB Temperature		-40		$^\circ\text{C}$
	Storage	PCB Temperature		-55		$^\circ\text{C}$
	Shutdown Temperature	PCB Temperature			+120	$^\circ\text{C}$

NOTE 1: Measured at 20 MHz bandwidth across a $6\mu\text{f}$ multi layer ceramic capacitor located approximately 1" from output terminals.

MECHANICAL (THROUGH HOLE)

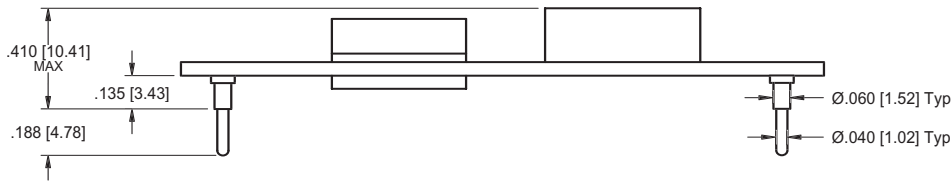

PIN FUNCTIONS	
1	+Vin
2	Remote On/Off
3	-Vin
4	+Vout2
5	Return
6	Trim
7	+Vout1

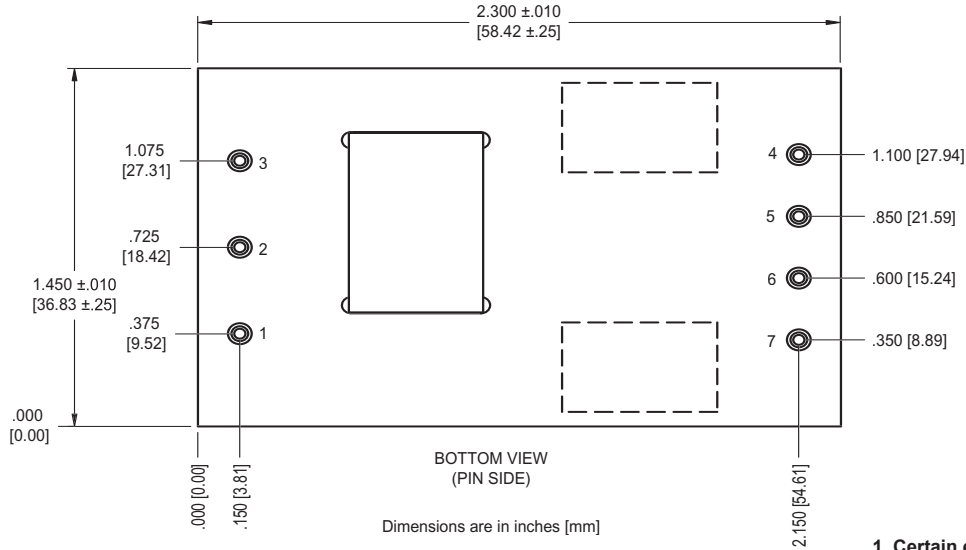

NOTES:

- Pin placement tolerance: $\pm .010$
- Pin material: Copper¹
- Pin Finish: Matte Tin over Nickel¹
- Converter weight: [24g]

1. Certain early production units may use Brass pins with a Tin/Lead over Nickel Finish

ORDERING INFORMATION (THROUGH HOLE)

To Find Model Number

WPA60R48D **yz** -

Device Family _____
 60 Watt, Dual Output,
 Quarter Brick, 48VDC Input Range

Model Number _____
 Selected from Product Selection Chart (above)
 y = 15 = 1.5V, 18 = 1.8V, 22 = 2.2V, 25 = 2.5V,
 33 = 3.3V, 05 = 5.0V,
 z = 10 = 1.0V, 12 = 1.2V, 15 = 1.5V, 18 = 1.8V
 25 = 2.5V, 33 = 3.3V

Remote On/Off Logic and Pin Configuration _____
 No Number = Positive Logic, Through Hole
 1 = Negative Logic, Through Hole

Model Numbers	Part Numbers
WPA60R48D1510	6064965
WPA60R48D1812	6064957
WPA60R48D2215	6064956
WPA60R48D2518	6064955
WPA60R48D3312	6064953
WPA60R48D3318	6064952
WPA60R48D3325	6064951
WPA60R48D0515	6064966
WPA60R48D0533	6064954
WPA60R48D1510-1	6064993
WPA60R48D1812-1	6064992
WPA60R48D2215-1	6064991
WPA60R48D2518-1	6064990
WPA60R48D3312-1	6064989
WPA60R48D3318-1	6064988
WPA60R48D3325-1	6064987
WPA60R48D0515-1	6064994
WPA60R48D0533-1	6064986

MECHANICAL (SMT)

WPA60

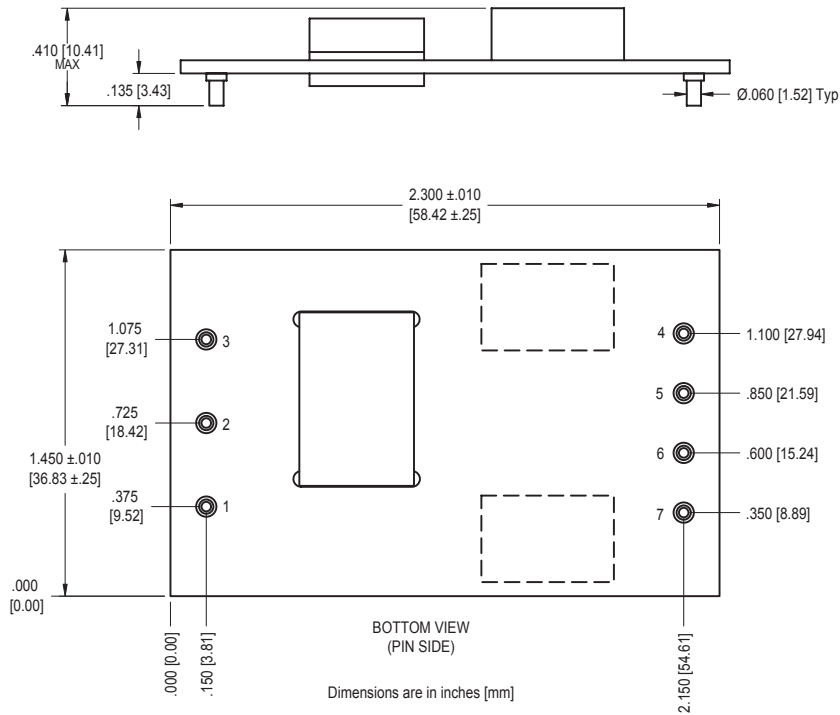

PIN FUNCTIONS	
1	+Vin
2	Remote On/Off
3	-Vin
4	+Vout2
5	Return
6	Trim
7	+Vout1

NOTES:

Pin placement tolerance: +.010
 Pin material: Copper
 Pin Finish: Matte Tin over Nickel with Tin/Lead coating on contact surface
 Converter weight: [24g]

PIN FUNCTIONS

- +Vin
- Remote ON/OFF
- Vin
- +Vout2
- Return
- Trim
- +Vout1

* Pin Co-Planarity within 0.004"

ORDERING INFORMATION (SMT)

To Find Model Number

WPA60R48D

yz

Device Family _____
 60 Watt, Dual Output,
 Quarter Brick, 48VDC Input Range
 Model Number _____
 Selected from Product Selection Chart (above)
 y = 15 = 1.5V, 18 = 1.8V, 22 = 2.2V, 25 = 2.5V,
 33 = 3.3V, 05 = 5.0V,
 z = 10 = 1.0V, 12 = 1.2V, 15 = 1.5V, 18 = 1.8V
 25 = 2.5V, 33 = 3.3V
 Remote On/Off Logic and Pin Configuration _____
 2 = Positive Logic, SMT
 3 = Negative Logic, SMT

Model Numbers

Part Numbers

WPA60R48D1510-2	WPA60R48D1510-2
WPA60R48D1812-2	WPA60R48D1812-2
WPA60R48D2215-2	WPA60R48D2215-2
WPA60R48D2518-2	WPA60R48D2518-2
WPA60R48D3312-2	WPA60R48D3312-2
WPA60R48D3318-2	WPA60R48D3318-2
WPA60R48D3325-2	WPA60R48D3325-2
WPA60R48D0515-2	WPA60R48D0515-2
WPA60R48D0533-2	WPA60R48D0533-2
WPA60R48D1510-3	WPA60R48D1510-3
WPA60R48D1812-3	WPA60R48D1812-3
WPA60R48D2215-3	WPA60R48D2215-3
WPA60R48D2518-3	WPA60R48D2518-3
WPA60R48D3312-3	WPA60R48D3312-3
WPA60R48D3318-3	WPA60R48D3318-3
WPA60R48D3325-3	WPA60R48D3325-3
WPA60R48D0515-3	WPA60R48D0515-3
WPA60R48D0533-3	WPA60R48D0533-3

Operation

Output Voltage Trim

Each of the WPA60's output voltages may be simultaneously adjusted above or below the nominal set point by a value as indicated on the Product Data Sheet. As shown in **Figure 1**, to raise the converter output voltage a resistor must be placed between the Trim pin and Return pin.

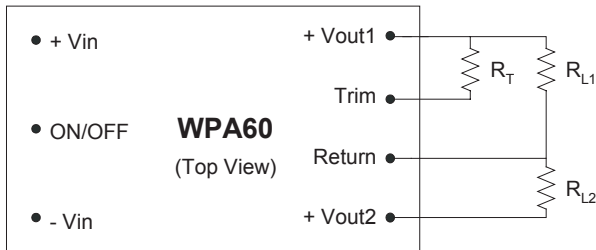

Figure 1 – Trim Up Circuit

To lower the converter output voltage a resistor must be placed between the Trim pin and Vout1 pin as shown in **Figure 2**.

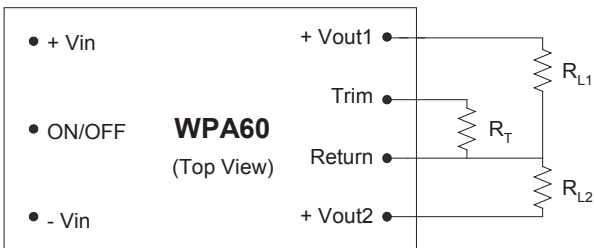

Figure 2 – Trim Down Circuit

The resistance value required to achieve the desired amount of positive/negative trim can be determined by referring to the trim graph for each model. If trimming is not desired then the Trim pin should be left unconnected.

Remote ON/OFF Function

The WPA60 is equipped with a primary ON/OFF pin used to remotely turn the converter on or off via a system signal. The input is TTL open-collector and/or FET open-drain compatible. For the positive logic model a system logic low signal will turn the unit off. For negative logic models a system logic high signal will turn the converter off. For negative logic models where no control signal will be used the ON/OFF pin should be connected directly to $-V_{in}$ to ensure proper operation. For positive logic models where no control signal will be used the ON/OFF pin should be left open for normal operation.

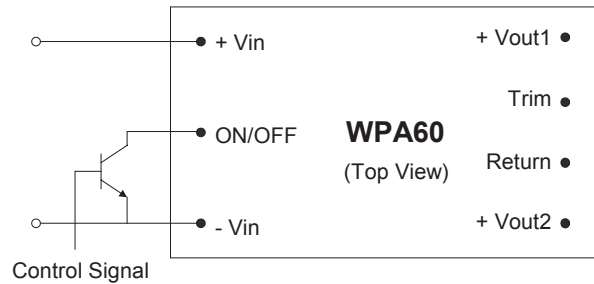

Figure 3 – Remote ON/OFF Control Circuit

Protective Functions

Temperature Shutdown

The over temperature shutdown feature of the WPA60 will cause the unit to shutdown at a typical pwb temperature of 120°C. This protective feature is comprised of a thermistor in the unit control loop. At a temperature of 120°C this circuit will cause the PWM to go into an idle mode, resulting in no output from the converter and preventing damage to the converter components. When the temperature of the unit drops below 120°C the fault condition will clear and the converter will resume normal operation. If the cause of the over temperature condition is not identified and corrected the unit will continue to cycle on and off.

Input Under-Voltage Shutdown

The nominal input voltage for the WPA60 is 48Vdc. At an input voltage of 32.5Vdc nominal the unit will shutdown on an input under-voltage condition. At an input voltage less than 32.5V the under-voltage sensing circuit will send a signal to the PWM causing it to go into idle mode. This will result in no output from the converter, protecting the unit from a high input current condition. When the input voltage returns to a level above 32.5V the unit will return to normal operation. The unit will typically turn on at an input voltage of 34.5V nominal as indicated on the Product Data Sheet. This is due to hysteresis designed into the protective circuit to prevent excessive cycling of the converter.

Output Short Circuit Protection

When a short circuit condition appears on the output the converter will go into hiccup mode. In hiccup mode the converter will cycle on and off repeatedly until the short circuit condition is cleared.

Safety

The WPA60 meets safety requirements per UL/CUL 60950 and VDE to EN60950. Additionally, the converter meets CISPR22/ EN55022/ FCC15J Class B specs for EMI levels with external filtering.

Performance Characterization

Thermal Derating

Maximum output current vs. ambient temperature at various airflow rates has been determined for each model of the WPA60. From these graphs, the combination of maximum ambient temperature and minimum airflow for select output current combinations can be determined. Each model was analyzed for maximum allowable output power over an ambient temperature range of 0 to 85°C and for airflows up to 600LFM. In each case the maximum allowable power at a given airflow and ambient temperature is defined as the point at which a known component reaches its individual temperature limit.

Efficiency

Efficiency data for each model was determined as a function of Load Current and Input Voltage. Efficiency vs. Load Current was measured at an ambient temperature of 25°C, an airflow of 300LFM with an input voltage of 48Vdc. Efficiency vs. Input Voltage was measured at an ambient temperature of 25°C, an airflow of 300LFM and rated load. Graphs for each model are provided in their respective section.

Start-Up, ON/OFF and Transient Response

For each model, waveforms are provided showing output voltage response and timing to input voltage power up/down, Remote ON/OFF state change and load current transient responses. Separate traces are provided showing the on/off timing sequence of the two outputs relative to one another. Output voltage transient responses are provided for step load changes of 50% - 100% of rated load current and 100% - 50% of rated load. Waveforms for each model are provided in their respective section.

PERFORMANCE CURVES: WPA60R48D0533 and WPA60R48D0533-1

MODEL WPA60R48D0533

Efficiency vs. Output Current @ $T_A = +25^\circ\text{C}$

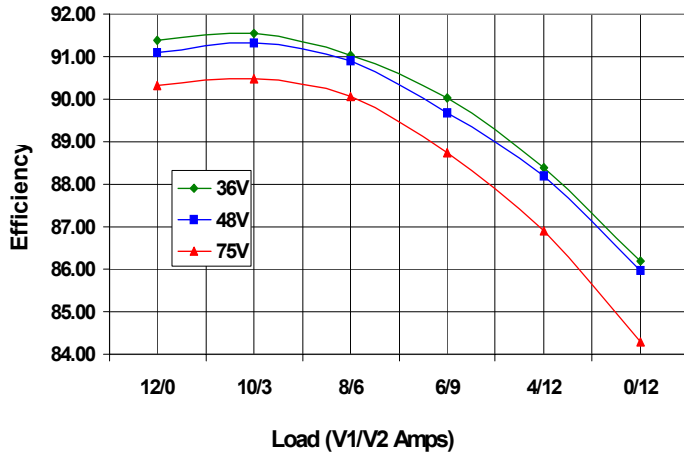

Efficiency vs. Input Voltage @ $T_A = +25^\circ\text{C}$

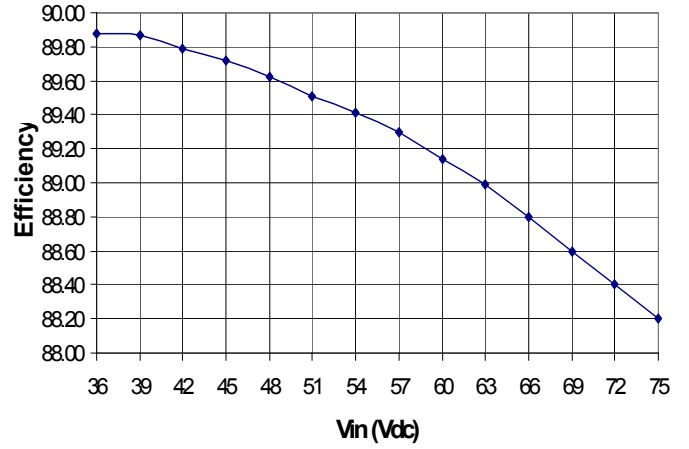

Trim Up Graph

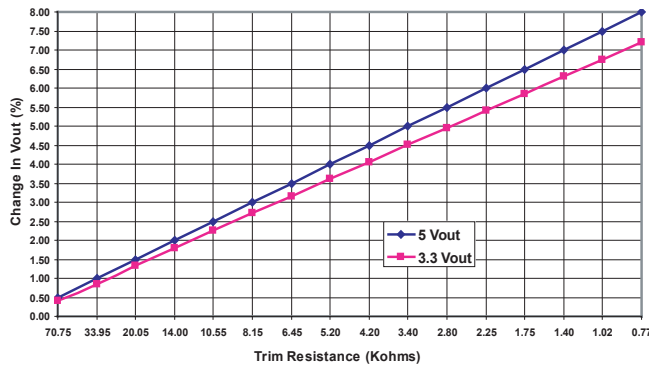

Trim Down Graph

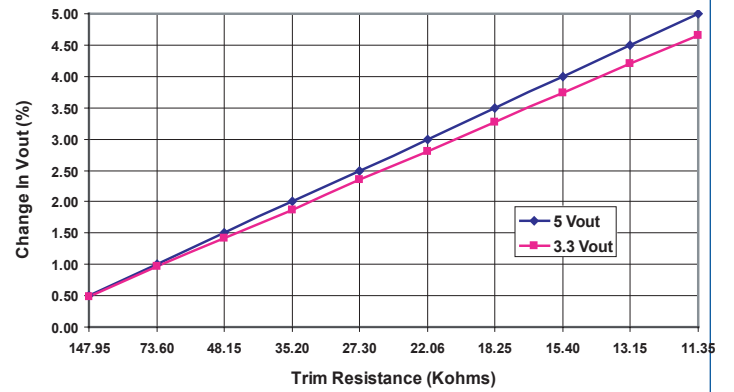

Turn On Time (VIN to VOUT)

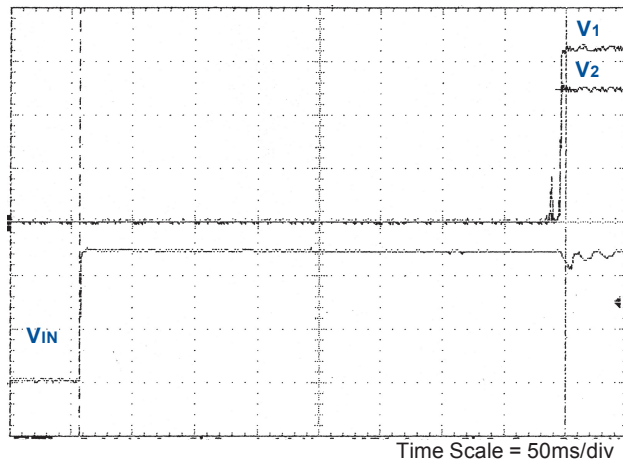

Rise Time (V1 and V2)

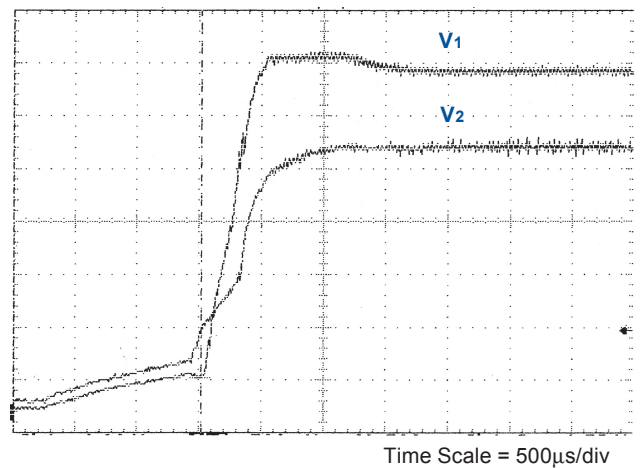

PERFORMANCE CURVES: WPA60R48D0533 and WPA60R48D0533-1

Turn Off Time (V_{IN} to V_{OUT})

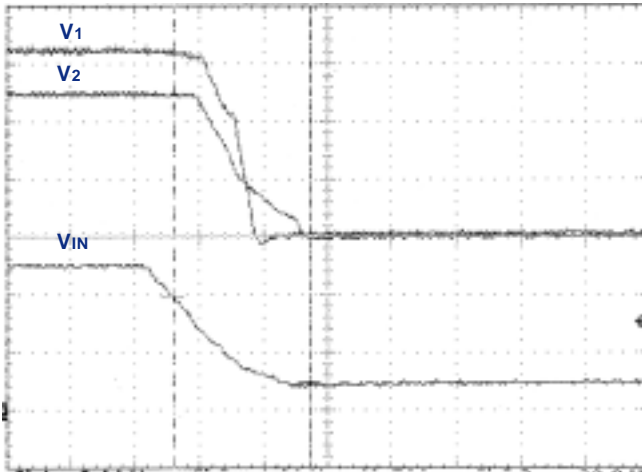

Time Scale = 500µs/div

Primary On Time (Primary Remote to V_{OUT})

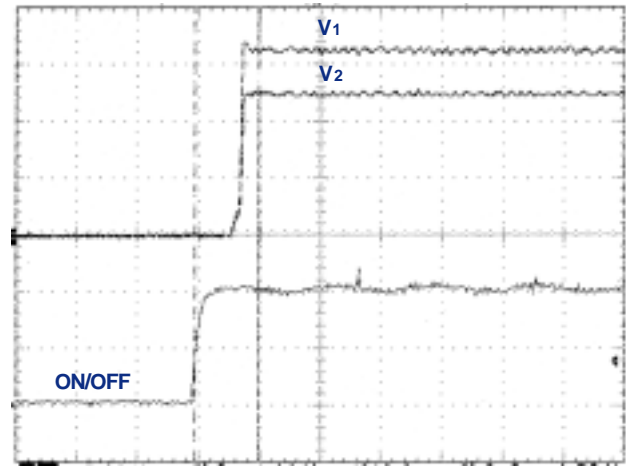

Time Scale = 10ms/div

**CH1 (5.0Vdc) Transient Response
50% to 100% Load Step**

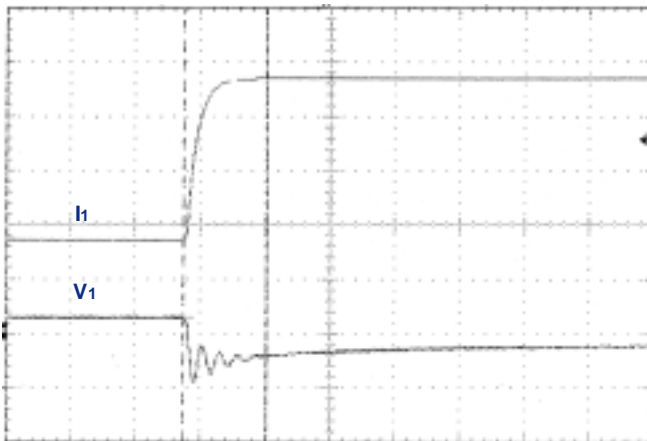

Voltage Scale = 100mV/div; Time Scale = 100µs/div
 $di/dt = 0.2A/\mu s$

**CH1 (5.0Vdc) Transient Response
100% to 50% Load Step**

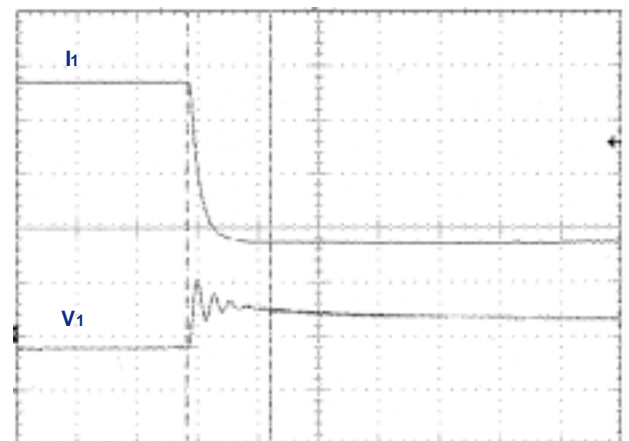

Voltage Scale = 100mV/div; Time Scale = 100µs/div
 $di/dt = 0.2A/\mu s$

**CH2 (3.3Vdc) Transient Response
50% to 100% Load Step**

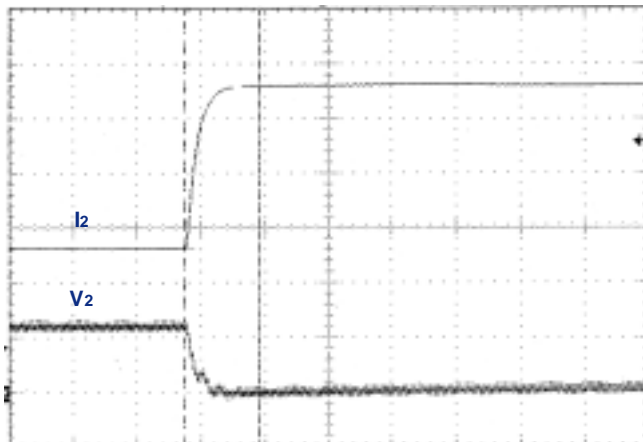

Voltage Scale = 50mV/div; Time Scale = 100µs/div
 $di/dt = 0.2A/\mu s$

**CH2 (3.3Vdc) Transient Response
100% to 50% Load Step**

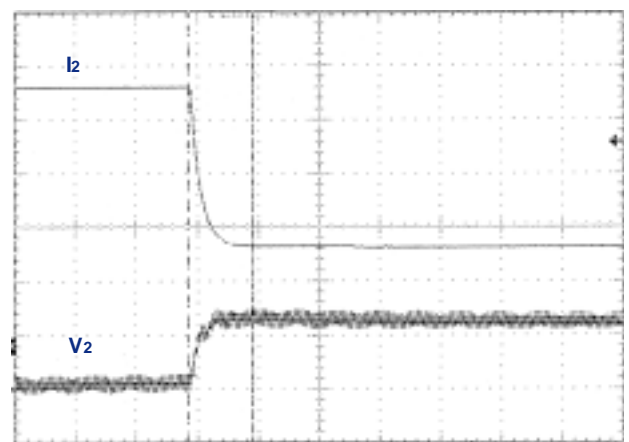

Voltage Scale = 50mV/div; Time Scale = 100µs/div
 $di/dt = 0.2A/\mu s$

PERFORMANCE CURVES: WPA60R48D0515 and WPA60R48D0515-1

MODEL WPA60R48D0515

Efficiency vs. Output Current @ $T_A = +25^\circ\text{C}$

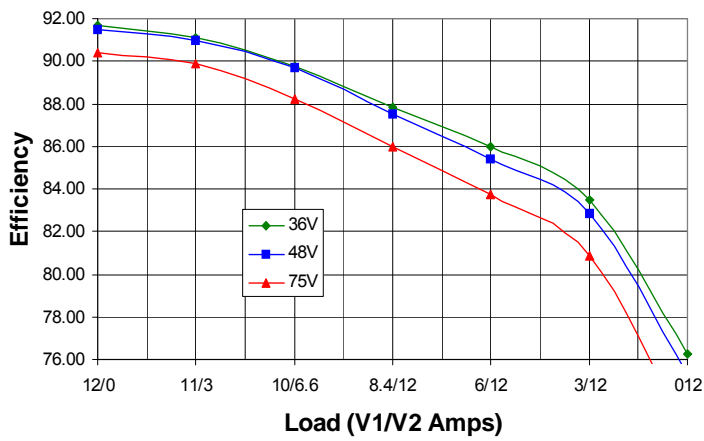

Trim Up Graph

Efficiency vs. Input Voltage @ $T_A = +25^\circ\text{C}$

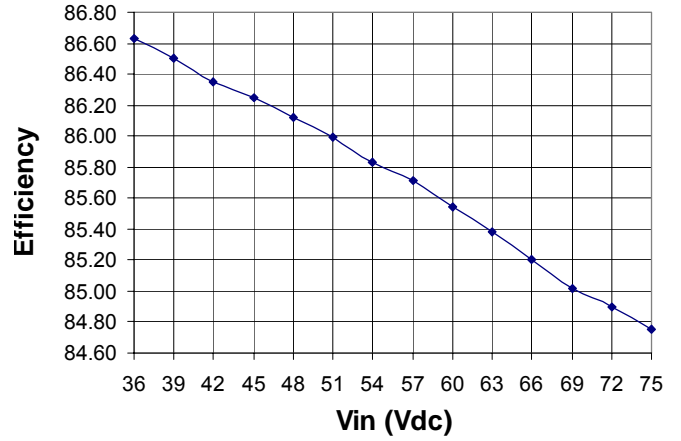

Trim Down Graph

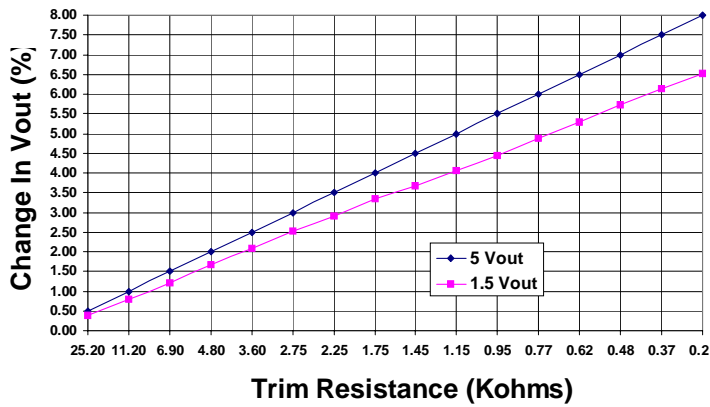

Turn On Time (V_{IN} to V_{OUT})

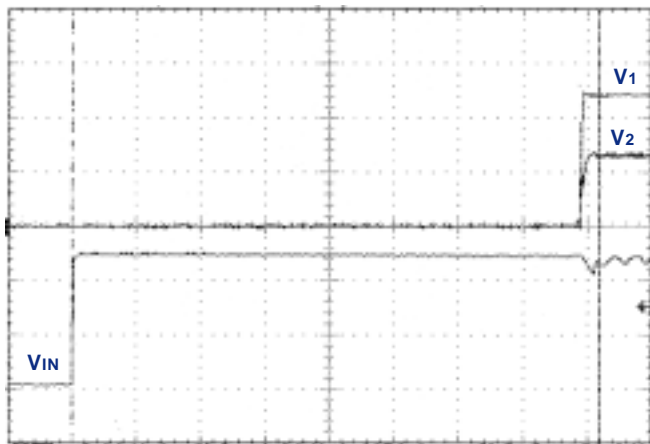

Time Scale = 50ms/div

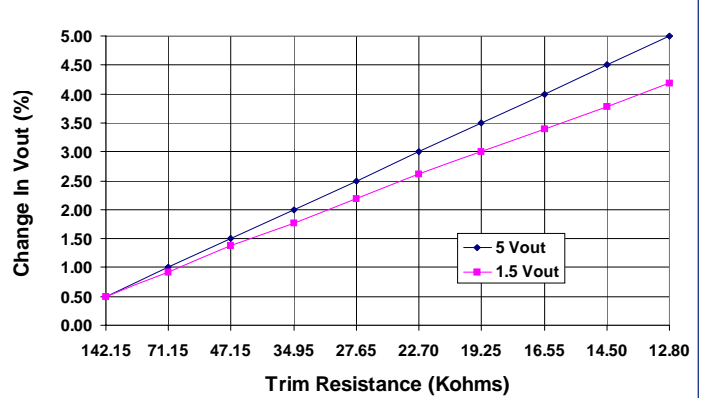

Rise Time (V_1 and V_2)

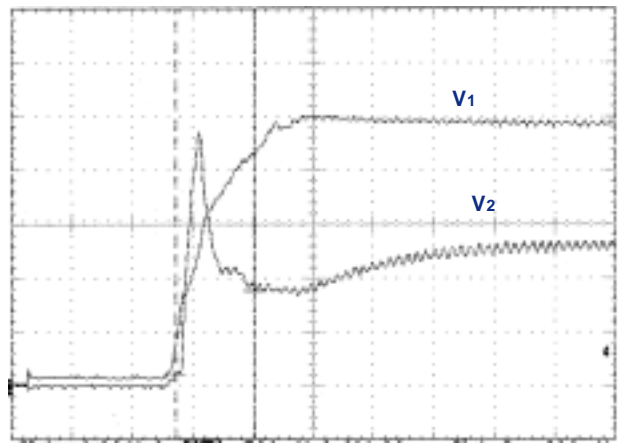

Time Scale = 1ms/div

PERFORMANCE CURVES: WPA60R48D0515 and WPA60R48D0515-1

Turn Off Time (V_{IN} to V_{OUT})

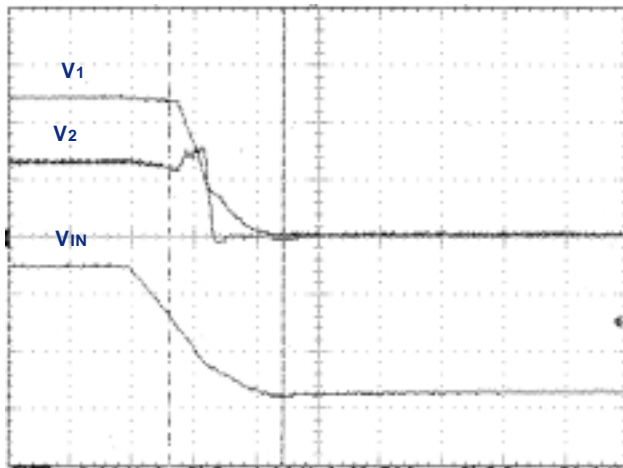

Time Scale = 500 μ s/div

CH1 (5.0Vdc) Transient Response
50% to 100% Load Step

Primary On Time (Primary Remote to V_{OUT})

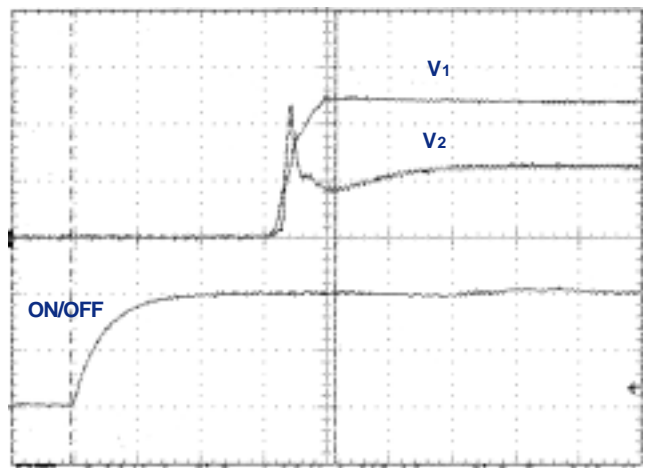

Time Scale = 2ms/div

CH1 (5.0Vdc) Transient Response
100% to 50% Load Step

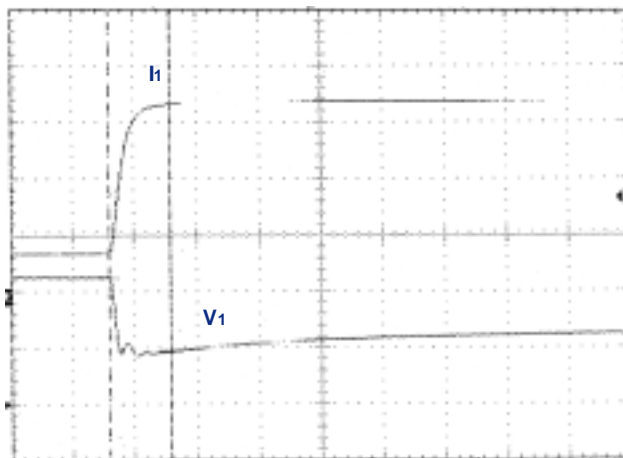

Voltage Scale = 100mV/div; Time Scale = 100 μ s/div
di/dt = 0.2A/ μ s

CH2 (1.5Vdc) Transient Response
50% to 100% Load Step

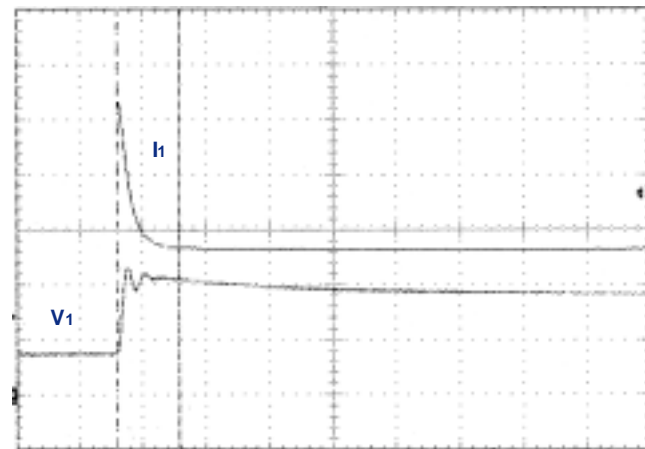

Voltage Scale = 100mV/div; Time Scale = 100 μ s/div
di/dt = 0.2A/ μ s

CH2 (1.5Vdc) Transient Response
100% to 50% Load Step

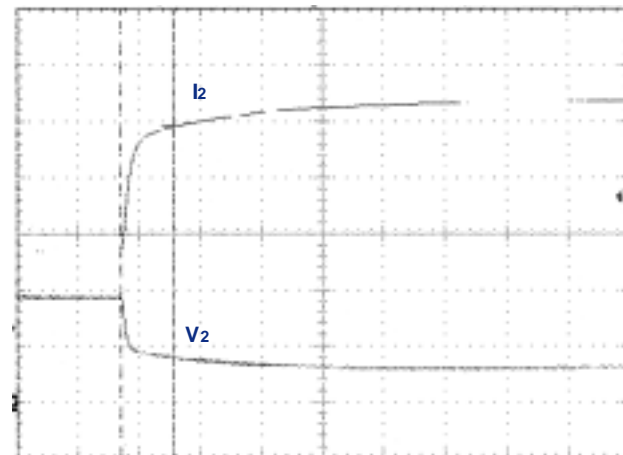

Voltage Scale = 100mV/div; Time Scale = 100 μ s/div
di/dt = 0.2A/ μ s

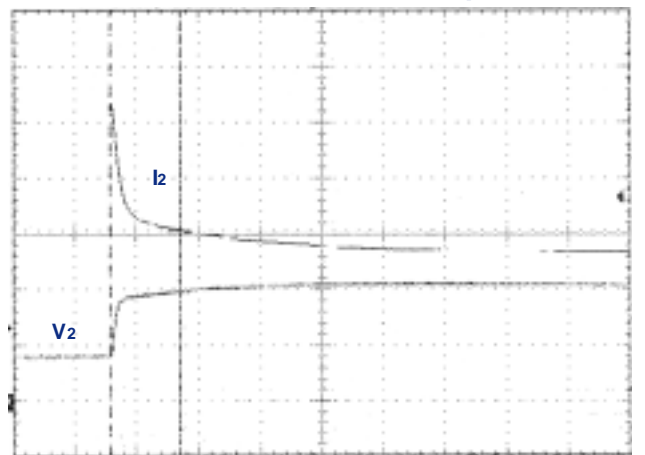

Voltage Scale = 100mV/div; Time Scale = 100 μ s/div
di/dt = 0.2A/ μ s

PERFORMANCE CURVES: WPA60R48D3325 and WPA60R48D3325-1

MODEL WPA60R48D3325

Efficiency vs. Output Current @ T_A = +25°C

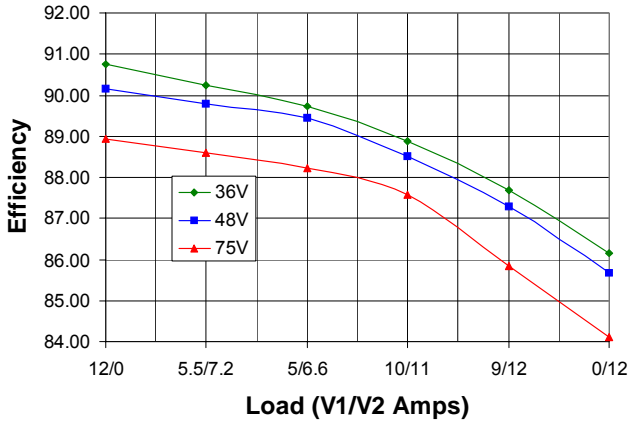

Efficiency vs. Input Voltage @ T_A = +25°C

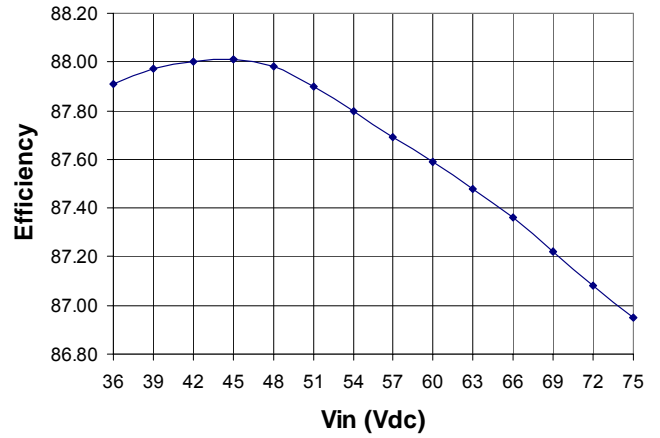

Trim Up Graph

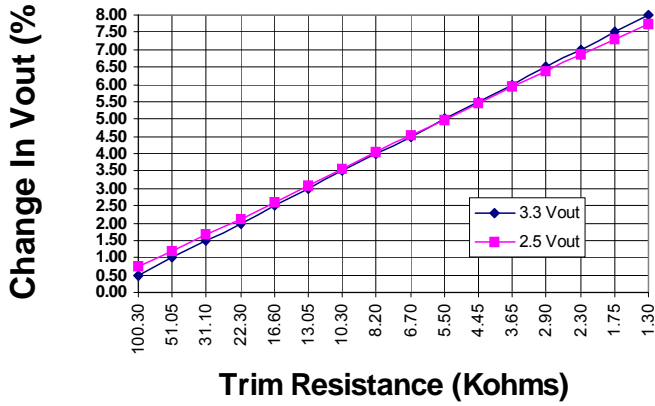

Trim Down Graph

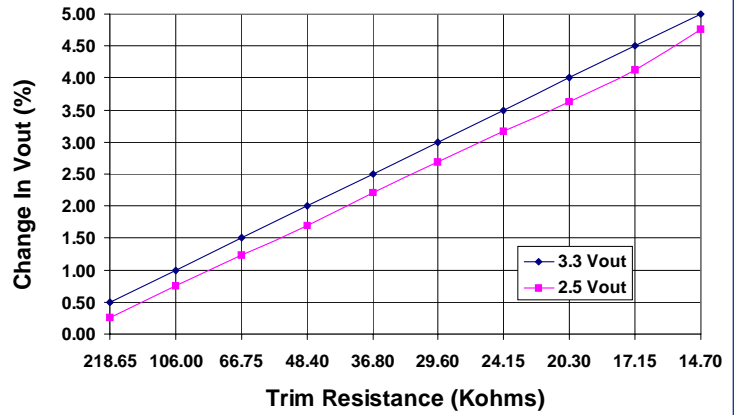

Turn On Time (VIN to VOUT)

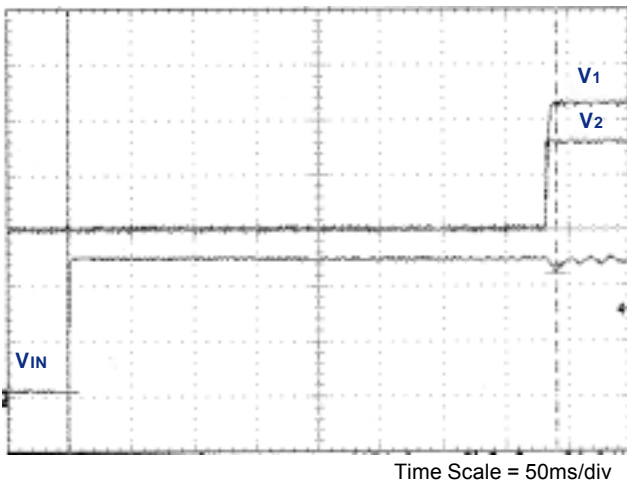

Rise Time (V1 and V2)

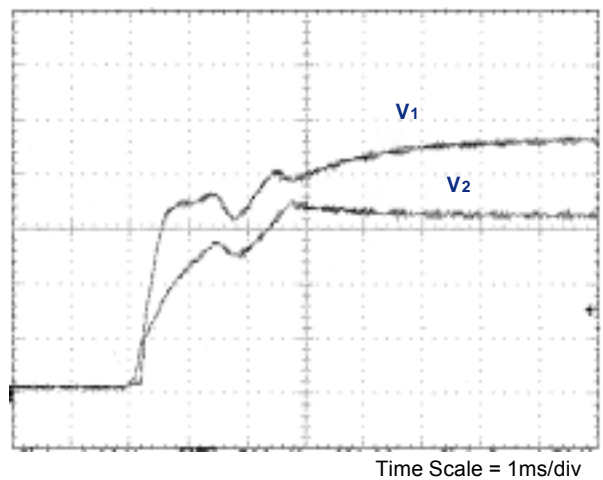

PERFORMANCE CURVES: WPA60R48D3325 and WPA60R48D3325-1

Turn Off Time (V_{IN} to V_{OUT})

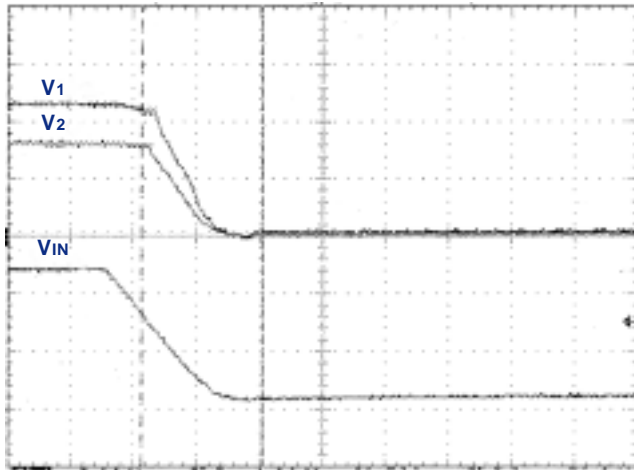

Time Scale = 500 μ s/div

Primary On Time (Primary Remote to V_{OUT})

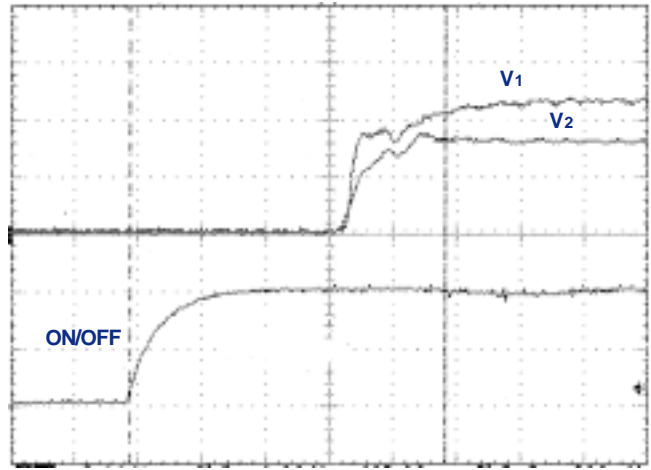

Time Scale = 2ms/div

CH1 (3.3Vdc) Transient Response
50% to 100% Load Step

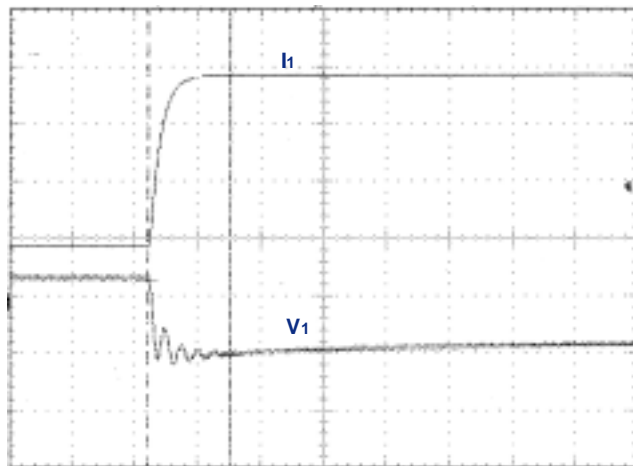

Voltage Scale = 100mV/div; Time Scale = 100 μ s/div
 $di/dt = 0.2A/\mu$ s

CH1 (3.3Vdc) Transient Response
100% to 50% Load Step

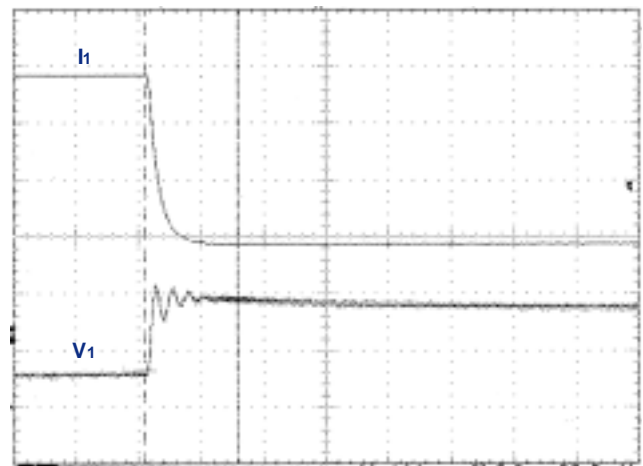

Voltage Scale = 100mV/div; Time Scale = 100 μ s/div
 $di/dt = 0.2A/\mu$ s

CH2 (2.5Vdc) Transient Response
50% to 100% Load Step

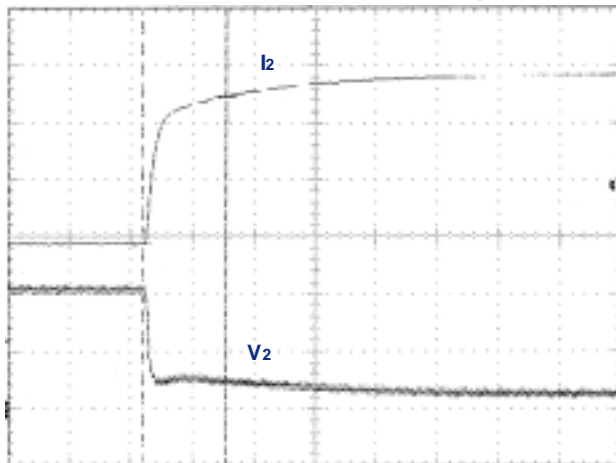

Voltage Scale = 50mV/div; Time Scale = 100 μ s/div
 $di/dt = 0.2A/\mu$ s

CH2 (2.5Vdc) Transient Response
100% to 50% Load Step

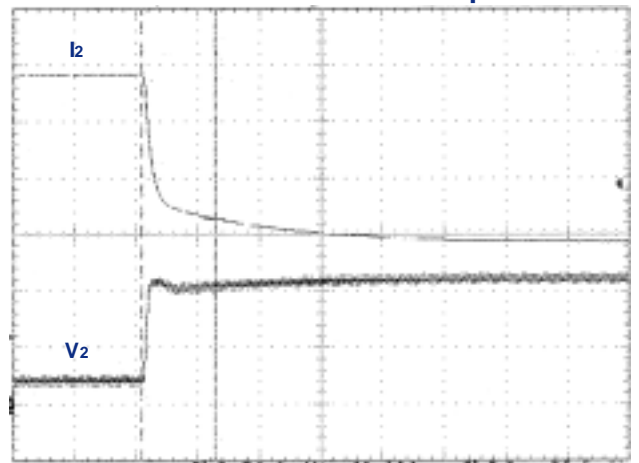

Voltage Scale = 50mV/div; Time Scale = 100 μ s/div
 $di/dt = 0.2A/\mu$ s

PERFORMANCE CURVES: WPA60R48D3318 and WPA60R48D3318-1

Efficiency vs. Output Current @ $T_A = +25^\circ\text{C}$

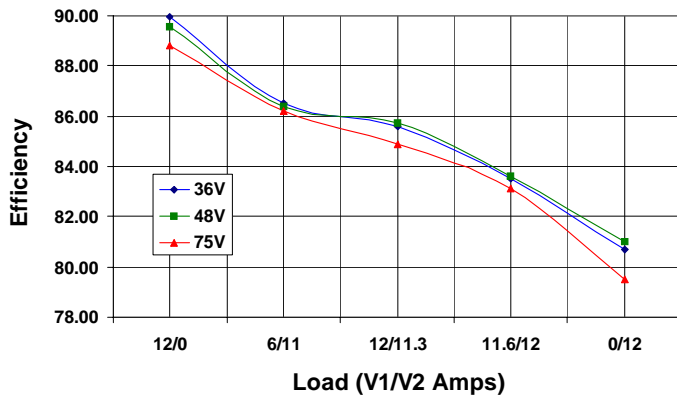

Efficiency vs. Input Voltage @ $T_A = +25^\circ\text{C}$

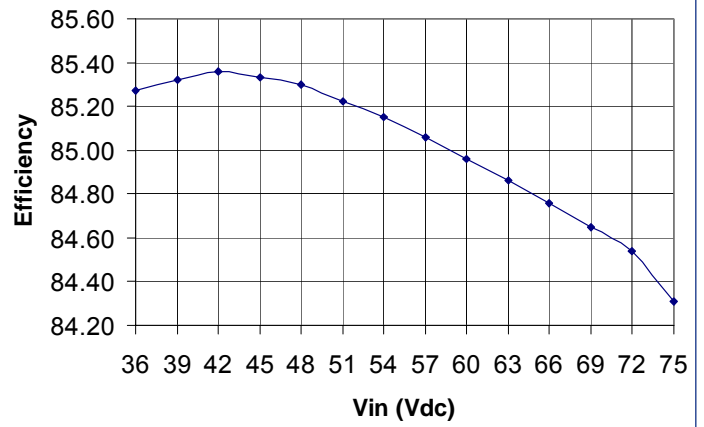

Trim Up Graph

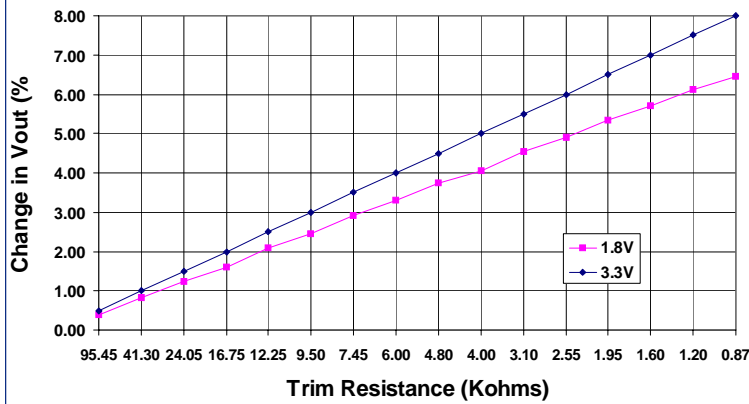

Trim Down Graph

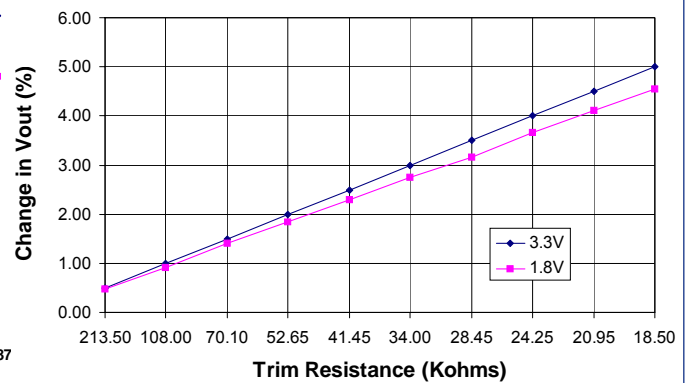

Turn On Time (V_{IN} to V_{OUT})

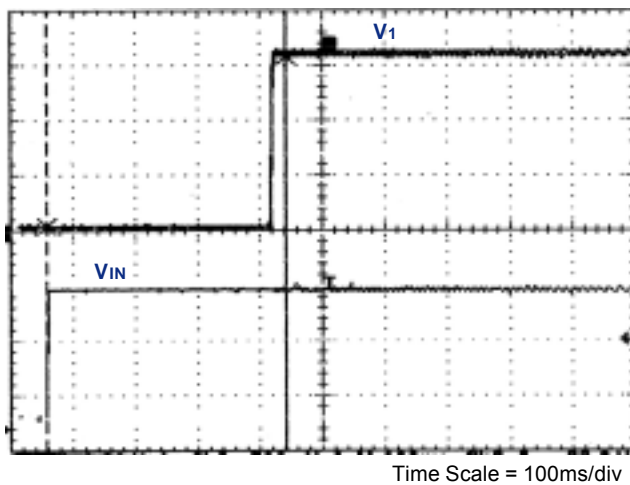

Rise Time (V_1 and V_2)

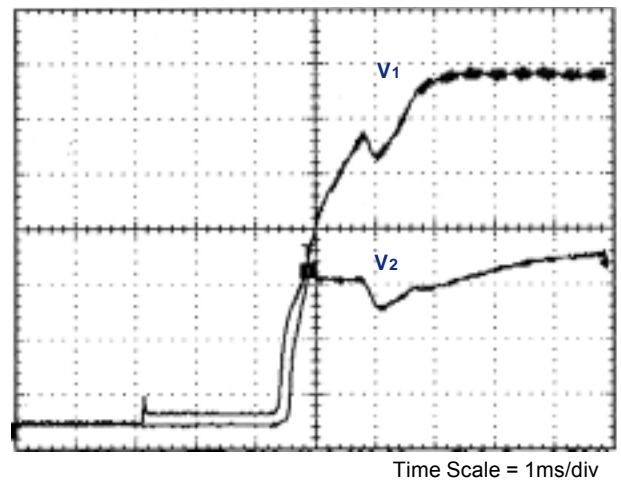

PERFORMANCE CURVES: WPA60R48D3318 and WPA60R48D3318-1

Turn Off Time (V_{IN} to V_{OUT})

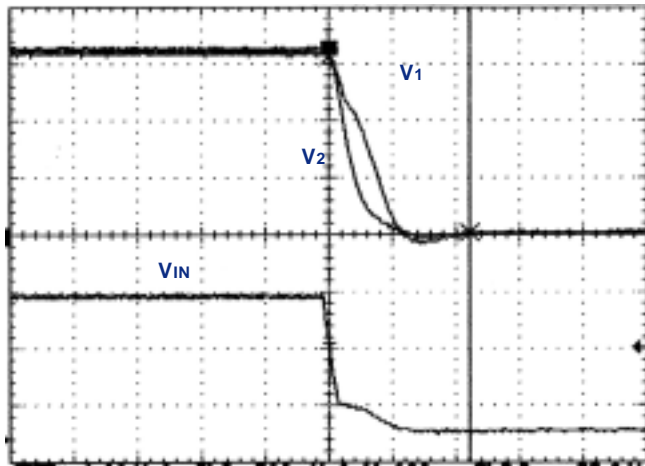

Time Scale = 100 μ s/div

Primary On Time (Primary Remote to V_{OUT})

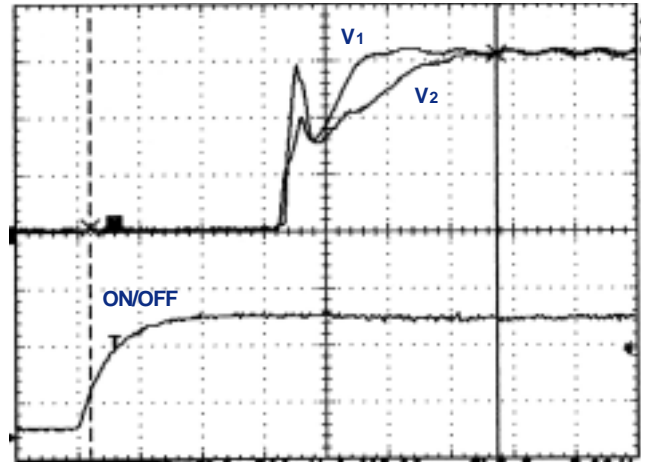

Time Scale = 2ms/div

**CH1 (3.3Vdc) Transient Response
50% to 100% Load Step**

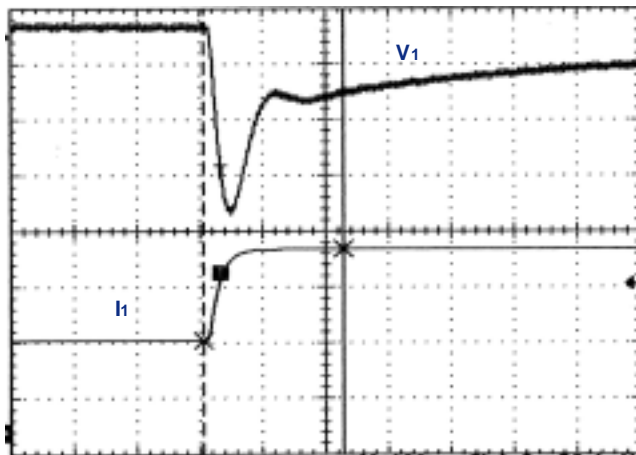

Voltage Scale = 100mV/div; Time Scale = 100 μ s/div
di/dt = 0.2A/ μ s

**CH1 (3.3Vdc) Transient Response
100% to 50% Load Step**

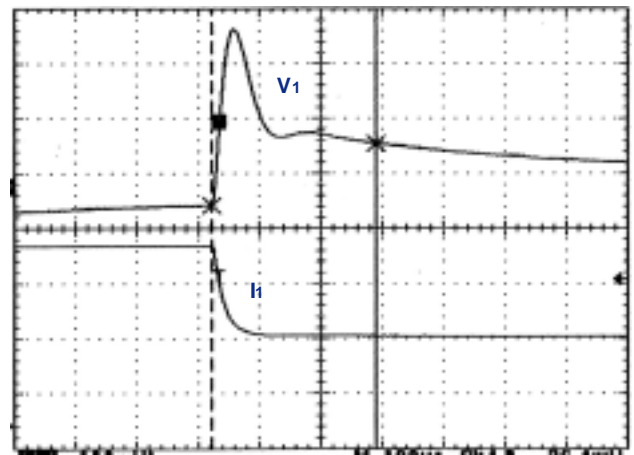

Voltage Scale = 100mV/div; Time Scale = 100 μ s/div
di/dt = 0.2A/ μ s

**CH2 (1.8Vdc) Transient Response
50% to 100% Load Step**

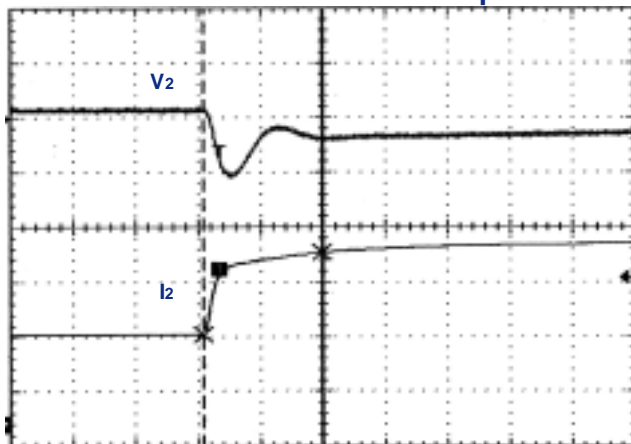

Voltage Scale = 50mV/div; Time Scale = 100 μ s/div
di/dt = 0.2A/ μ s

**CH2 (1.8Vdc) Transient Response
100% to 50% Load Step**

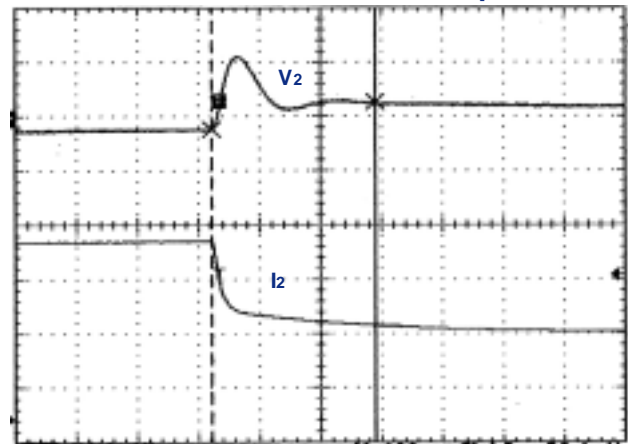

Voltage Scale = 50mV/div; Time Scale = 100 μ s/div
di/dt = 0.2A/ μ s

PERFORMANCE CURVES: WPA60R48D3312 and WPA60R48D3312-1

Efficiency vs. Output Current
@ $T_A = +25^\circ\text{C}$

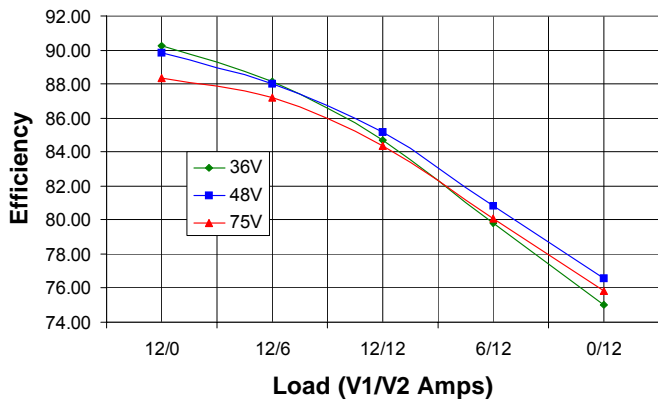

Efficiency vs. Input Voltage
@ $T_A = +25^\circ\text{C}$

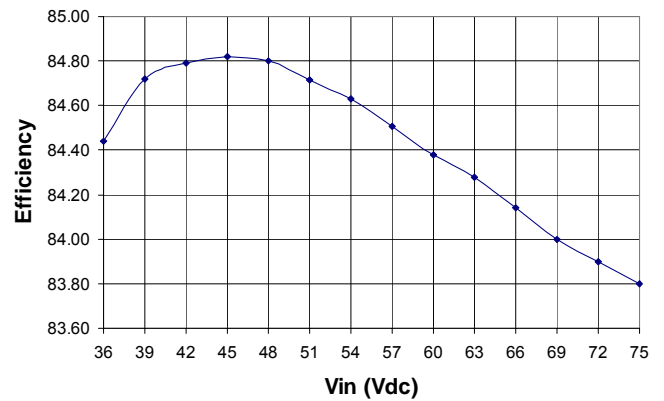

Trim Up Graph

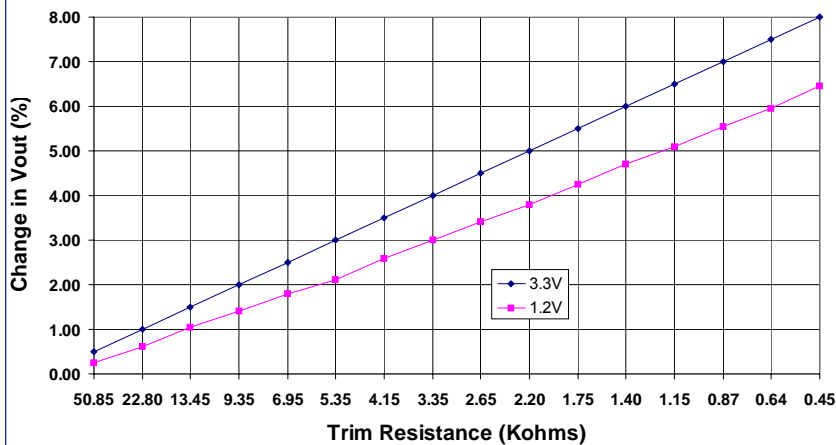

Trim Down Graph

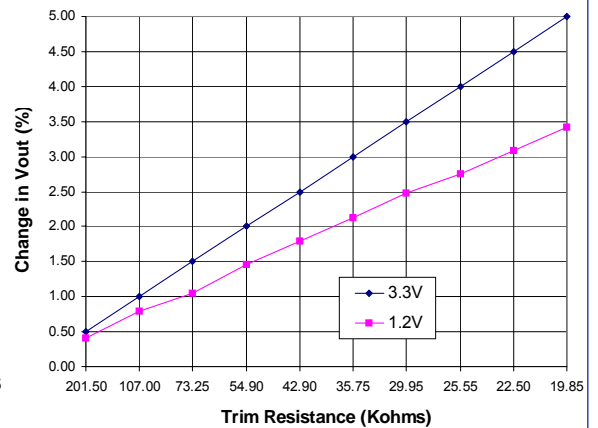

Turn On Time (V_{IN} to V_{OUT})

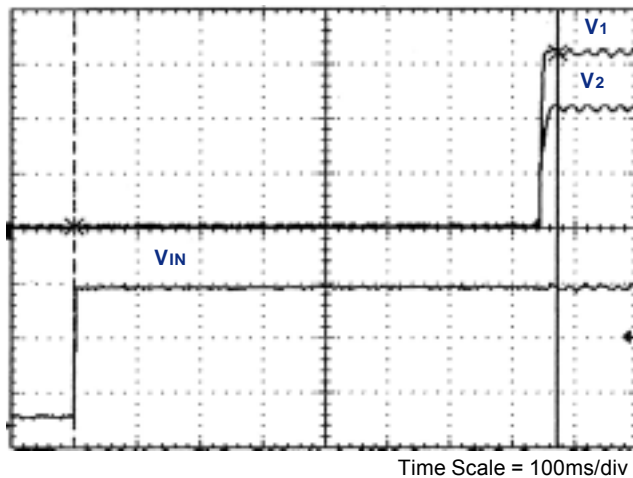

Rise Time (V_1 and V_2)

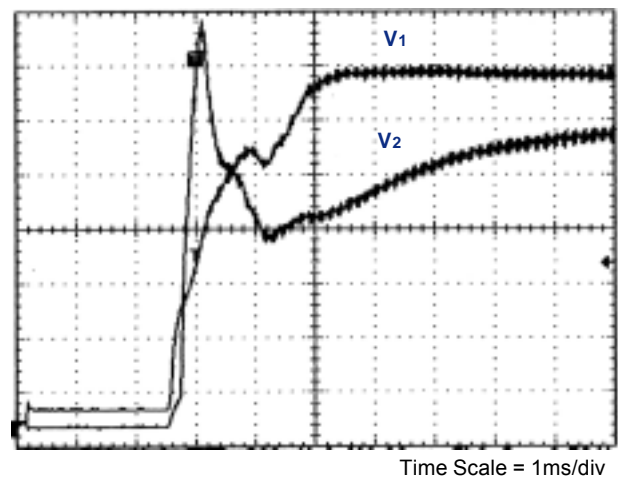

PERFORMANCE CURVES: WPA60R48D3312 and WPA60R48D3312-1

Turn Off Time (V_{IN} to V_{OUT})

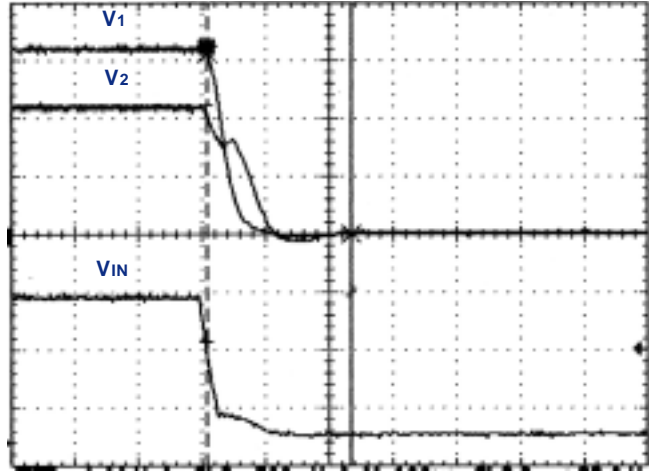

Time Scale = 100µs/div

**CH1 (3.3Vdc) Transient Response
50% to 100% Load Step**

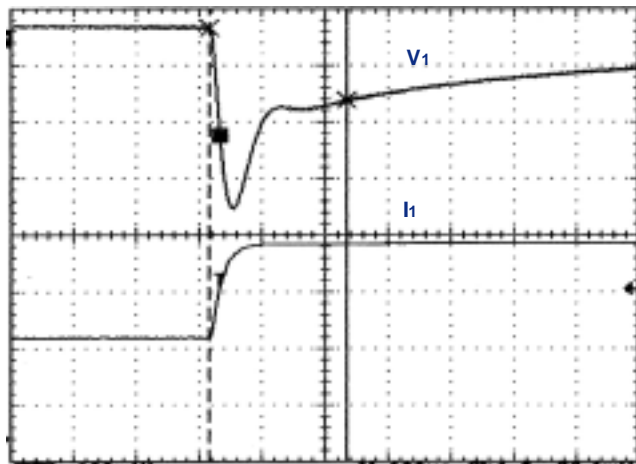

Voltage Scale = 100mV/div; Time Scale = 100µs/div
di/dt = 0.2A/µs

**CH2 (1.2Vdc) Transient Response
50% to 100% Load Step**

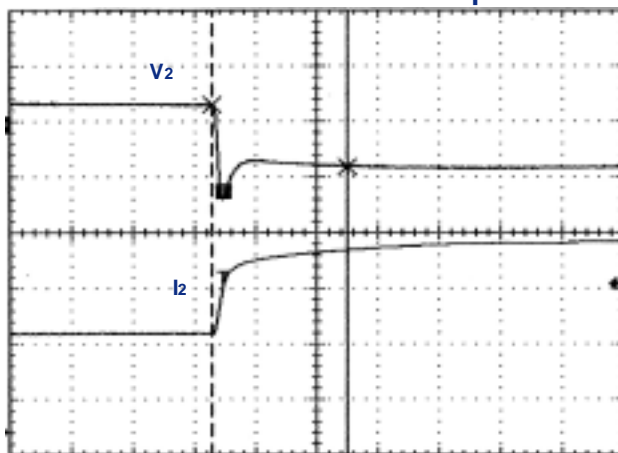

Voltage Scale = 50mV/div; Time Scale = 100µs/div
di/dt = 0.2A/µs

Primary On Time (Primary Remote to V_{OUT})

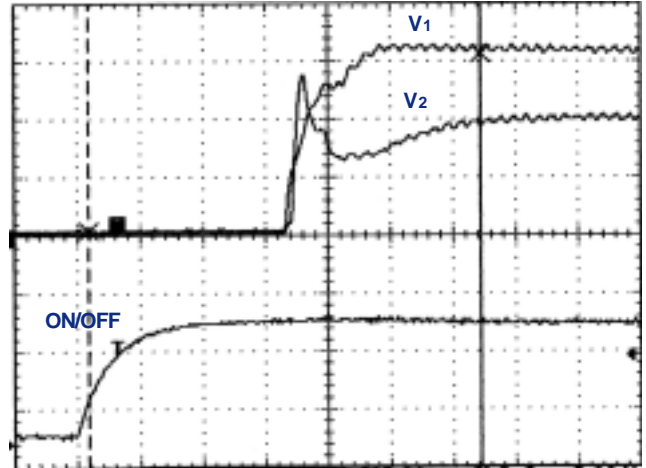

Time Scale = 2ms/div

**CH1 (3.3Vdc) Transient Response
100% to 50% Load Step**

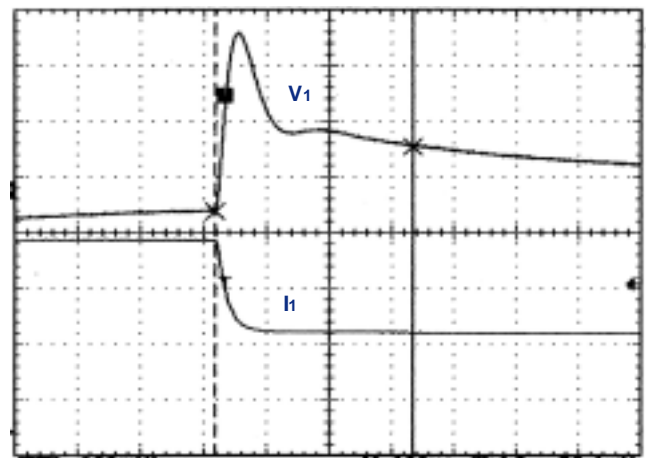

Voltage Scale = 100mV/div; Time Scale = 100µs/div
di/dt = 0.2A/µs

**CH2 (1.2Vdc) Transient Response
100% to 50% Load Step**

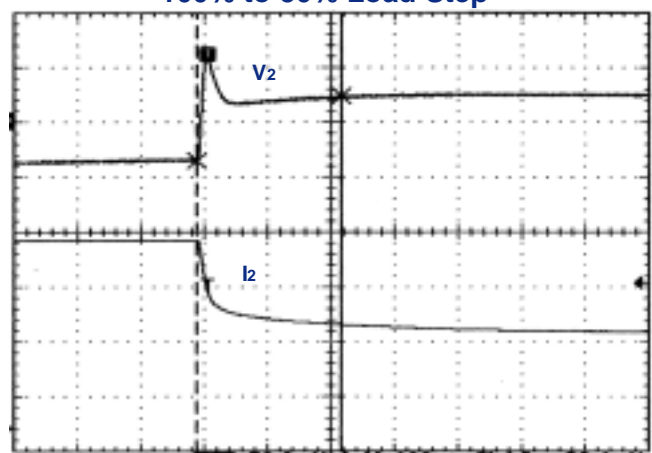

Voltage Scale = 50mV/div; Time Scale = 100µs/div
di/dt = 0.2A/µs

PERFORMANCE CURVES: WPA60R48D2518 and WPA60R48D2518-1

Efficiency vs. Output Current @ $T_A = +25^\circ\text{C}$

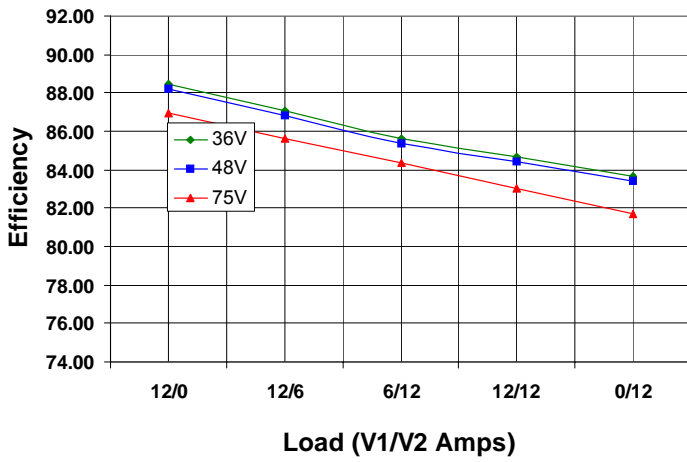

Efficiency vs. Input Voltage @ $T_A = +25^\circ\text{C}$

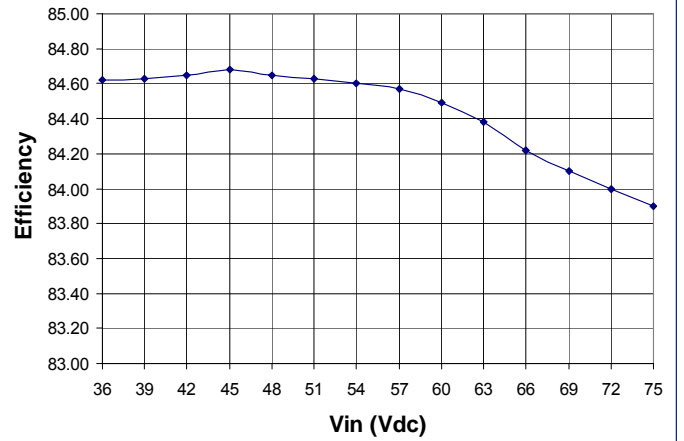

Trim Up Graph

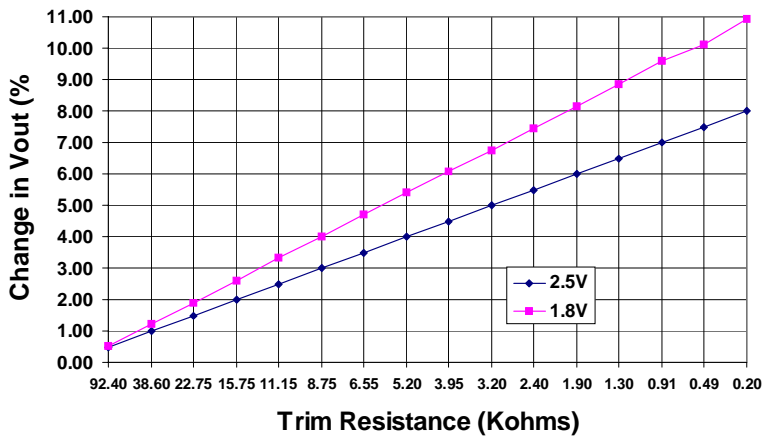

Trim Down Graph

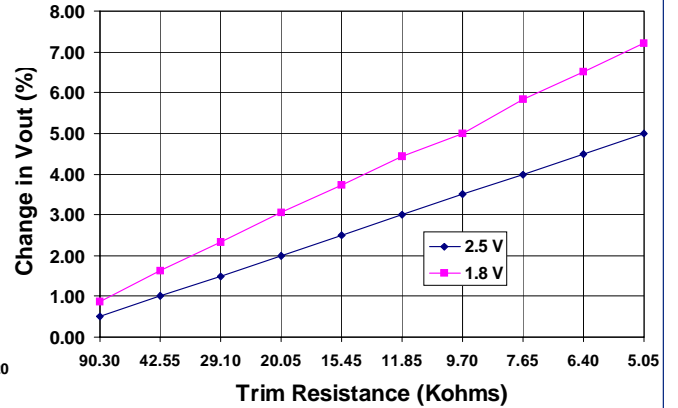

Turn On Time (V_{IN} to V_{OUT})

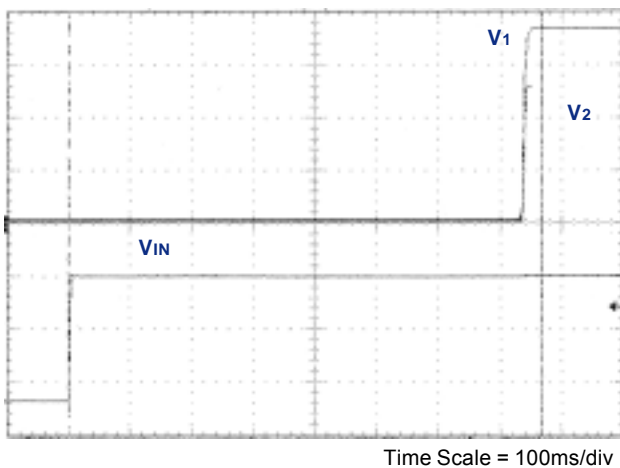

CH2 (1.8Vdc) Transient Response 100% to 50% Load Step

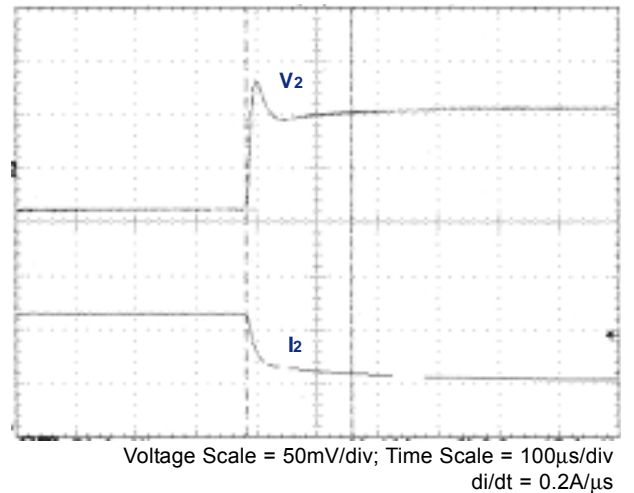

PERFORMANCE CURVES: WPA60R48D2518 and WPA60R48D2518-1

Turn Off Time (V_{IN} to V_{OUT})

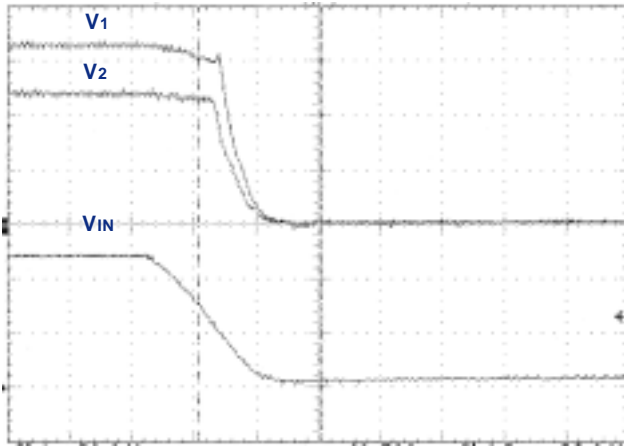

Time Scale = 500 μ s/div

Primary On Time (Primary Remote to V_{OUT})

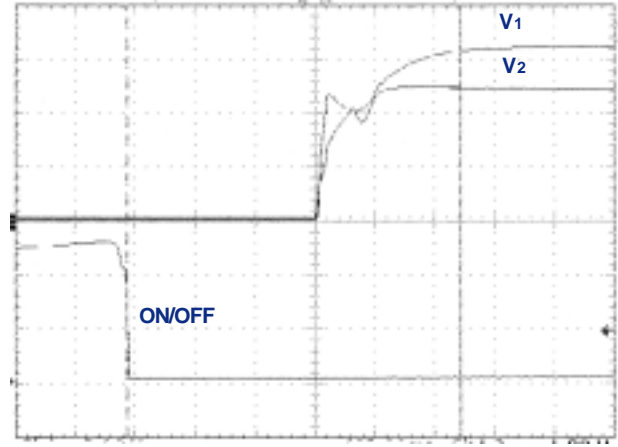

Time Scale = 2ms/div

**CH1 (2.5Vdc) Transient Response
50% to 100% Load Step**

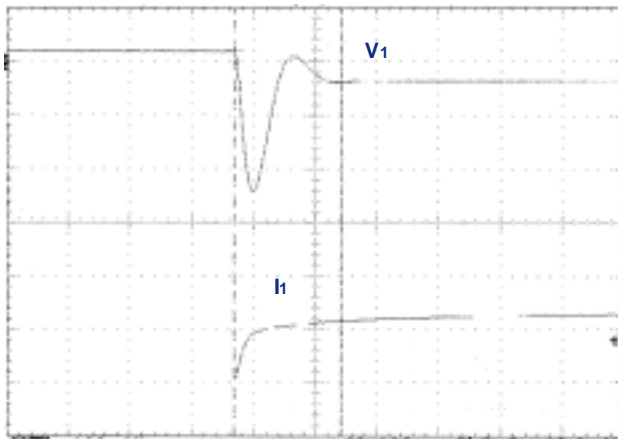

Voltage Scale = 100mV/div; Time Scale = 100 μ s/div
di/dt = 0.2A/ μ s

**CH1 (2.5Vdc) Transient Response
100% to 50% Load Step**

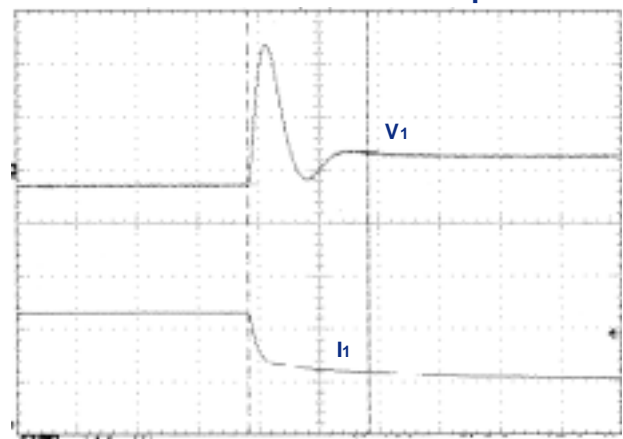

Voltage Scale = 100mV/div; Time Scale = 100 μ s/div
di/dt = 0.2A/ μ s

**CH2 (1.8Vdc) Transient Response
50% to 100% Load Step**

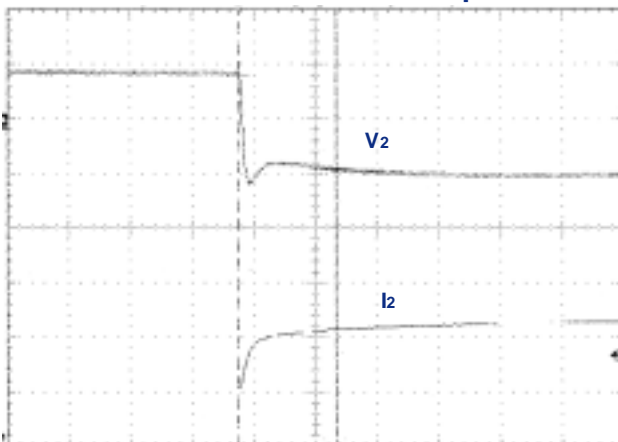

Voltage Scale = 50mV/div; Time Scale = 100 μ s/div
di/dt = 0.2A/ μ s

**CH2 (1.8Vdc) Transient Response
100% to 50% Load Step**

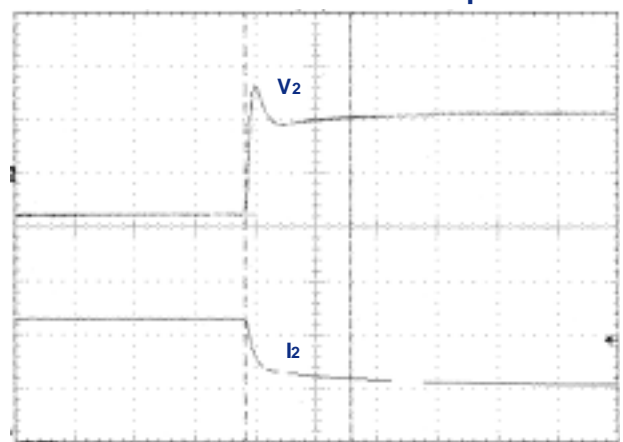

Voltage Scale = 50mV/div; Time Scale = 100 μ s/div
di/dt = 0.2A/ μ s

PERFORMANCE CURVES: WPA60R48D2215 and WPA60R48D2215-1

Efficiency vs. Output Current
@ $T_A = +25^\circ\text{C}$

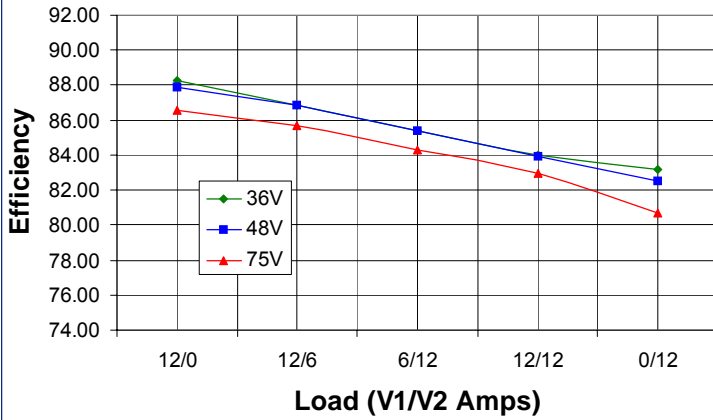

Efficiency vs. Input Voltage
@ $T_A = +25^\circ\text{C}$

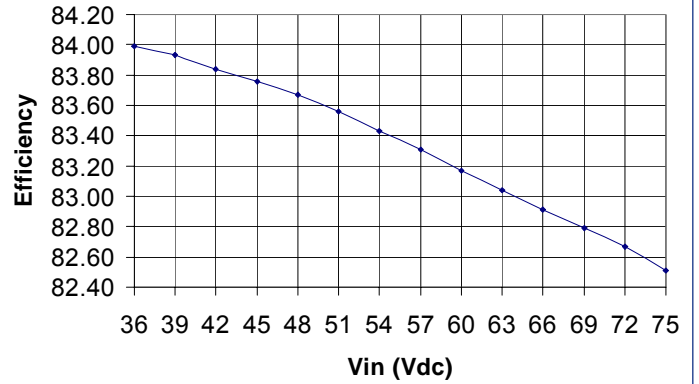

Trim Up Graph

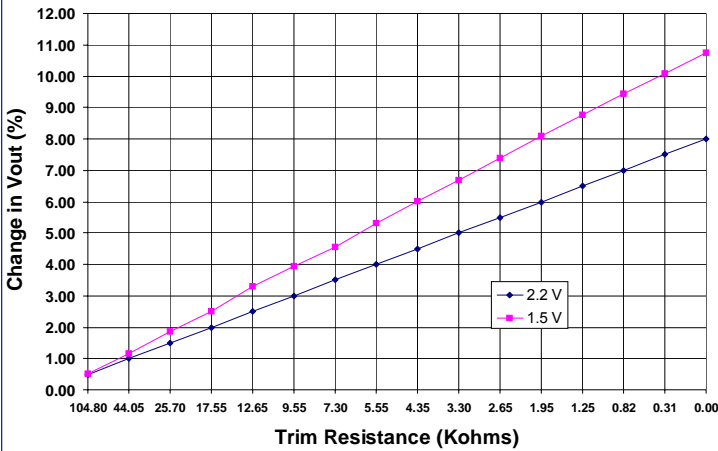

Trim Down Graph

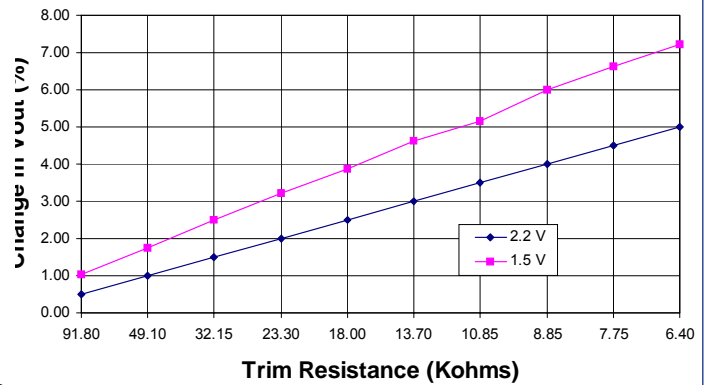

Turn On Time (VIN to VOUT)

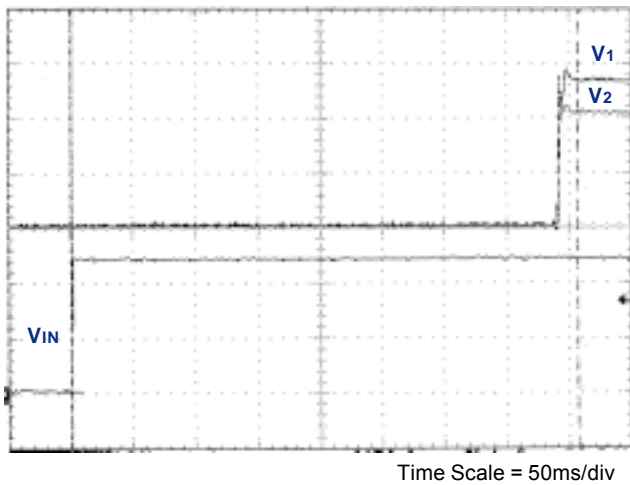

Rise Time (V1 and V2)

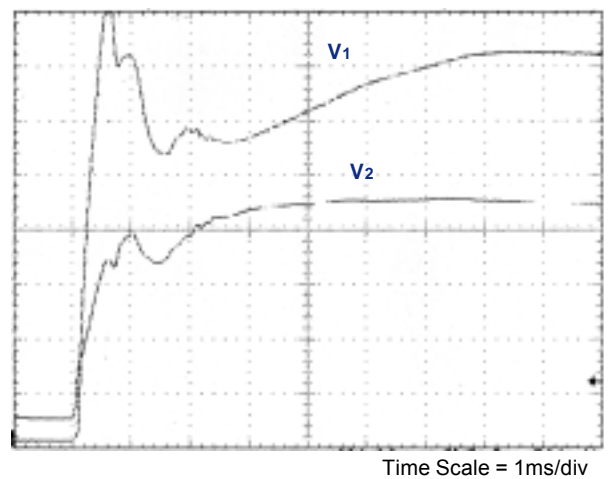

Turn Off Time (VIN to VOUT)

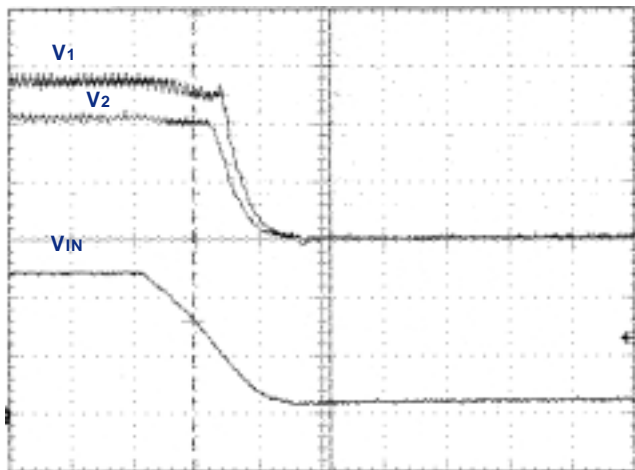

Time Scale = 500 μ s/div

Primary On Time (Primary Remote to VOUT)

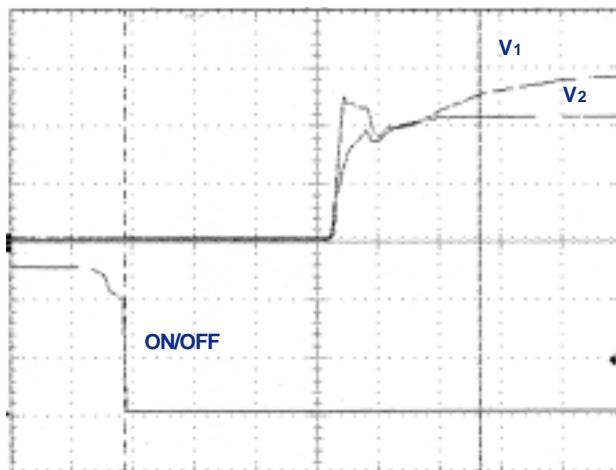

Time Scale = 2ms/div

**CH1 (2.2Vdc) Transient Response
50% to 100% Load Step**

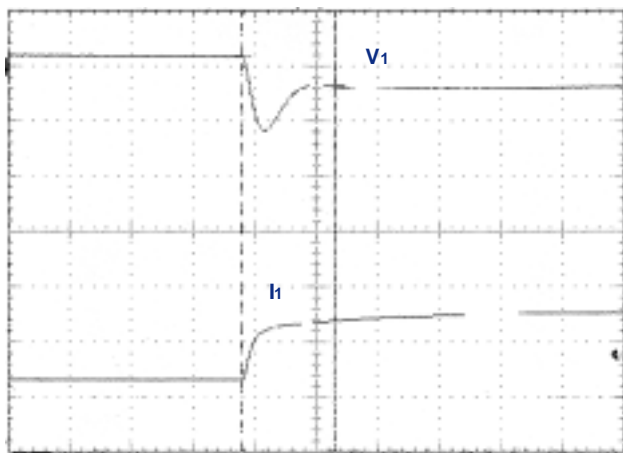

Voltage Scale = 200mV/div; Time Scale = 100 μ s/div
di/dt = 0.2A/ μ s

**CH1 (2.2Vdc) Transient Response
100% to 50% Load Step**

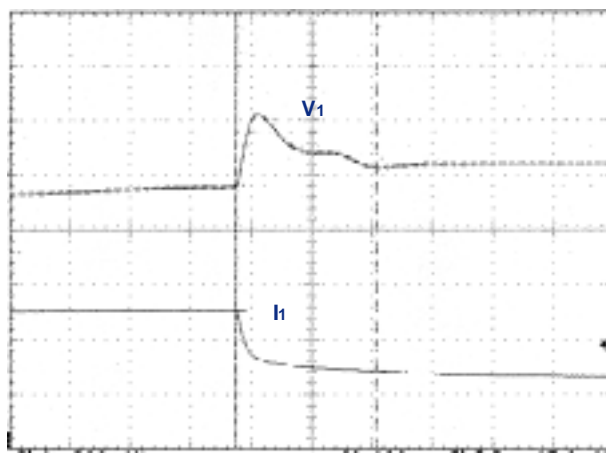

Voltage Scale = 200mV/div; Time Scale = 100 μ s/div
di/dt = 0.2A/ μ s

**CH2 (1.5Vdc) Transient Response
50% to 100% Load Step**

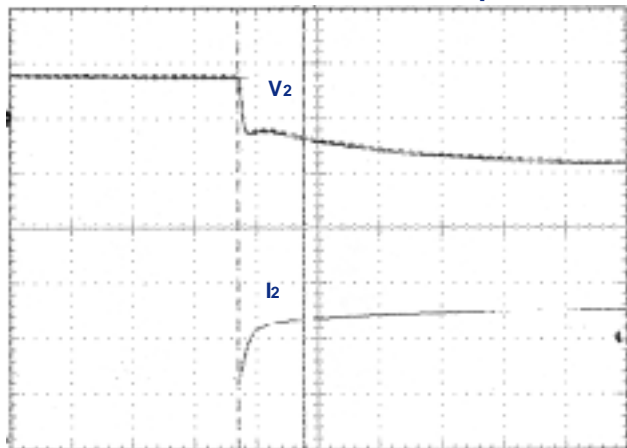

Voltage Scale = 50mV/div; Time Scale = 100 μ s/div
di/dt = 0.2A/ μ s

**CH2 (1.5Vdc) Transient Response
100% to 50% Load Step**

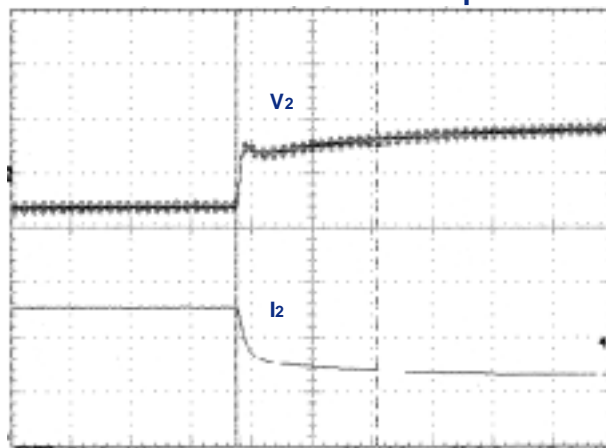

Voltage Scale = 50mV/div; Time Scale = 100 μ s/div
di/dt = 0.2A/ μ s

PERFORMANCE CURVES: WPA60R48D1812 and WPA60R48D1812-1

Efficiency vs. Output Current @ $T_A = +25^\circ\text{C}$

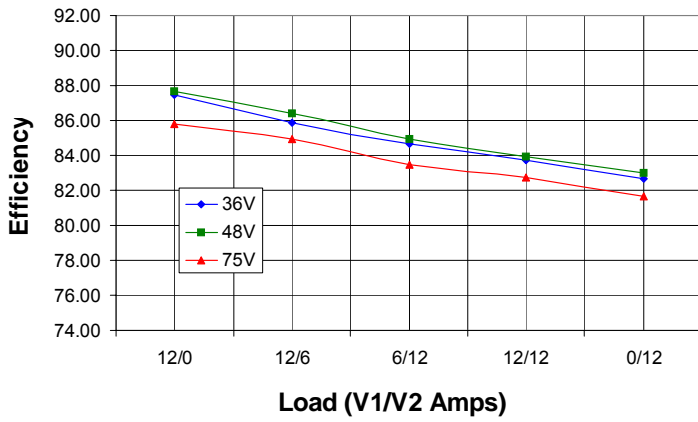

Efficiency vs. Input Voltage @ $T_A = +25^\circ\text{C}$

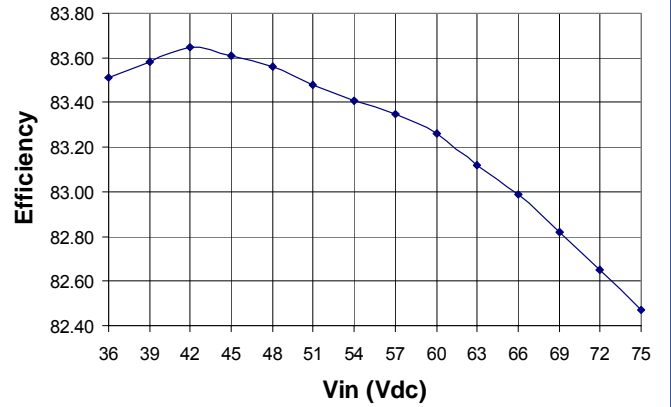

Trim Up Graph

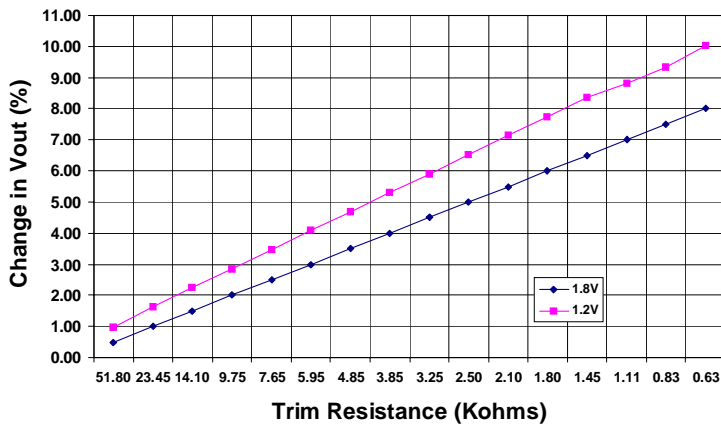

Trim Down Graph

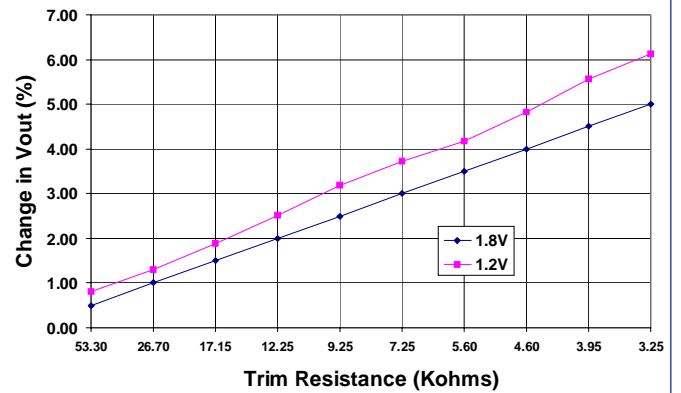

Turn On Time (V_{IN} to V_{OUT})

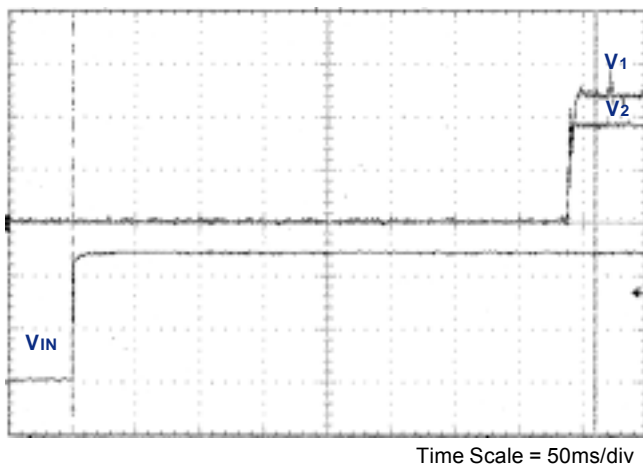

Rise Time (V_1 and V_2)

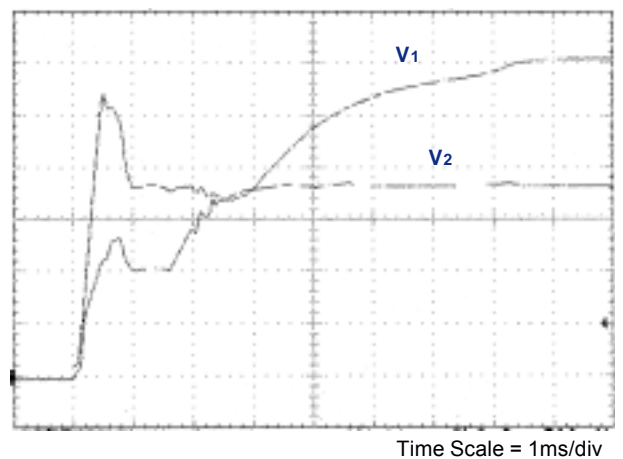

PERFORMANCE CURVES: WPA60R48D1812 and WPA60R48D1812-1

Turn Off Time (V_{IN} to V_{OUT})

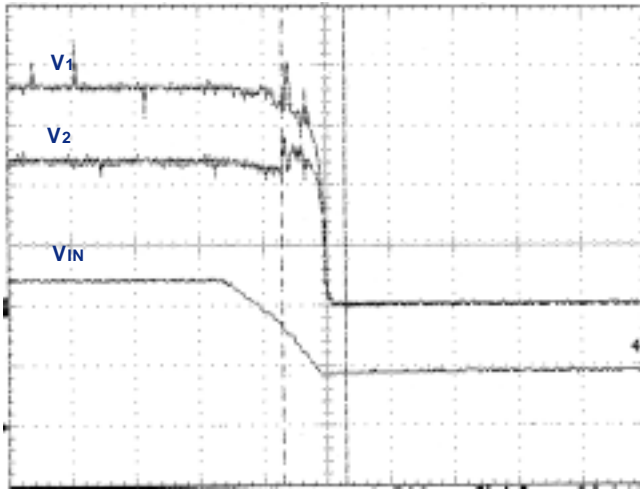

Time Scale = 500 μ s/div

Primary On Time (Primary Remote to V_{OUT})

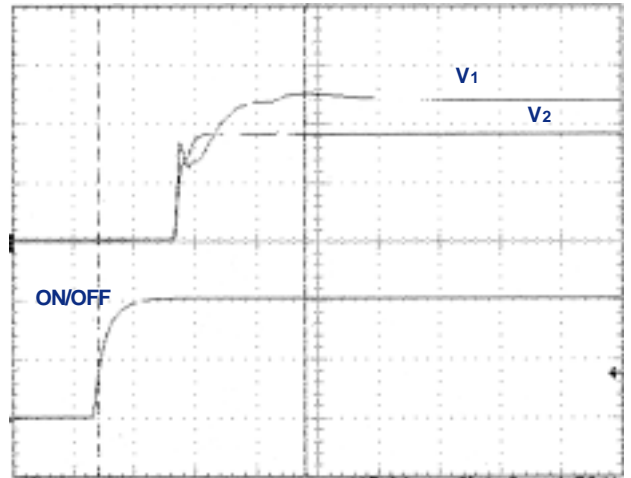

Time Scale = 5ms/div

**CH1 (1.8Vdc) Transient Response
50% to 100% Load Step**

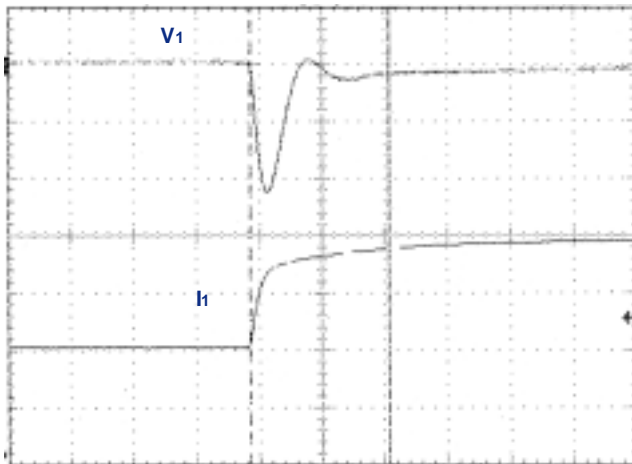

Voltage Scale = 100mV/div; Time Scale = 100 μ s/div
di/dt = 0.2A/ μ s

**CH1 (1.8Vdc) Transient Response
100% to 50% Load Step**

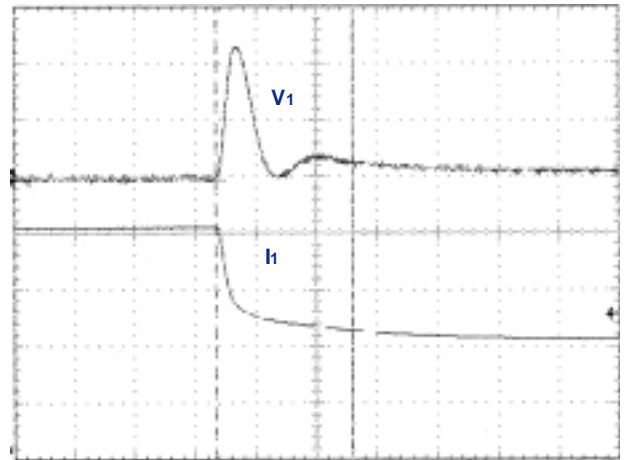

Voltage Scale = 100mV/div; Time Scale = 100 μ s/div
di/dt = 0.2A/ μ s

**CH2 (1.2Vdc) Transient Response
50% to 100% Load Step**

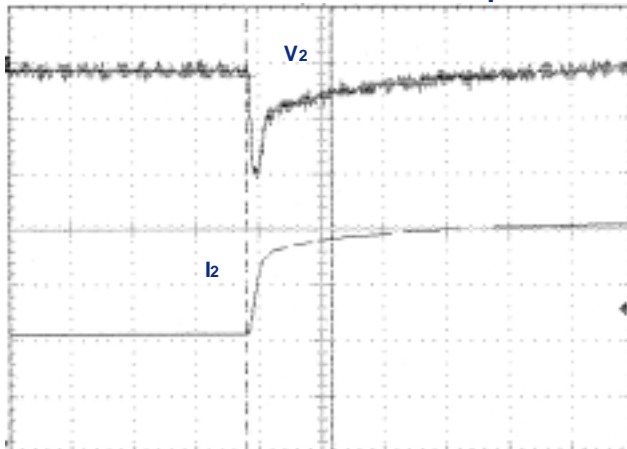

Voltage Scale = 20mV/div; Time Scale = 100 μ s/div
di/dt = 0.2A/ μ s

**CH2 (1.2Vdc) Transient Response
100% to 50% Load Step**

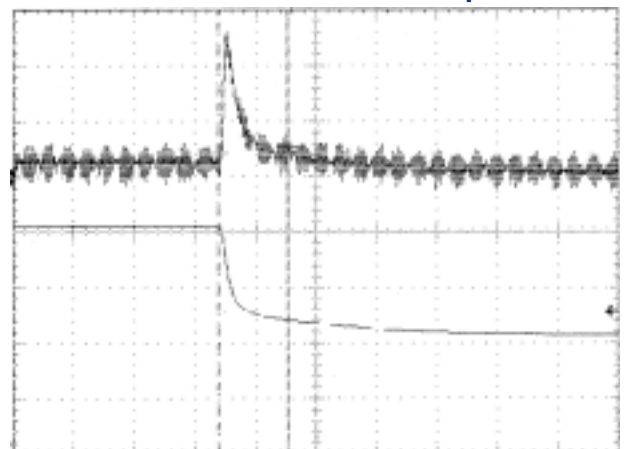

Voltage Scale = 20mV/div; Time Scale = 100 μ s/div
di/dt = 0.2A/ μ s

PERFORMANCE CURVES: WPA60R48D1510 and WPA60R48D1510-1

Efficiency vs. Output Current
@ T_A = +25°C

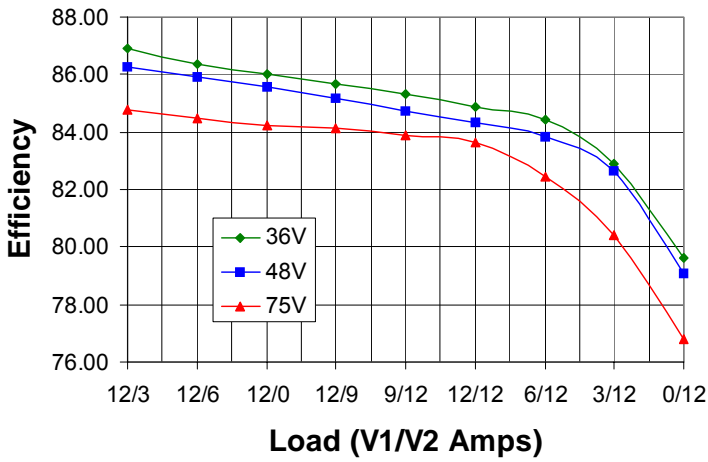

Trim Up Graph

Efficiency vs. Input Voltage
@ T_A = +25°C

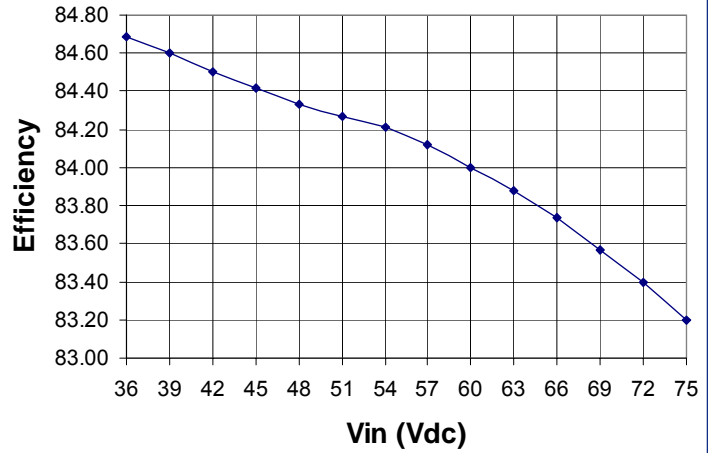

Trim Down Graph

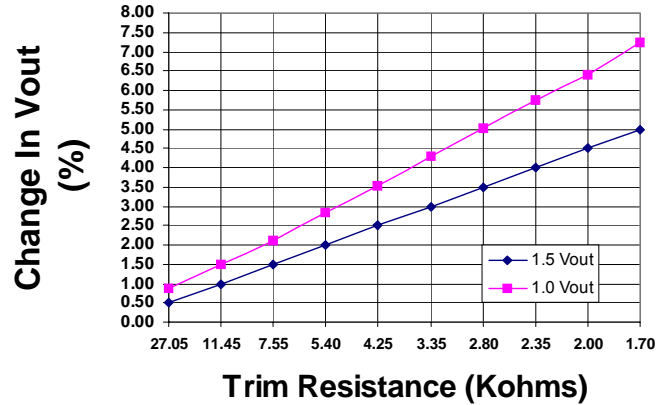
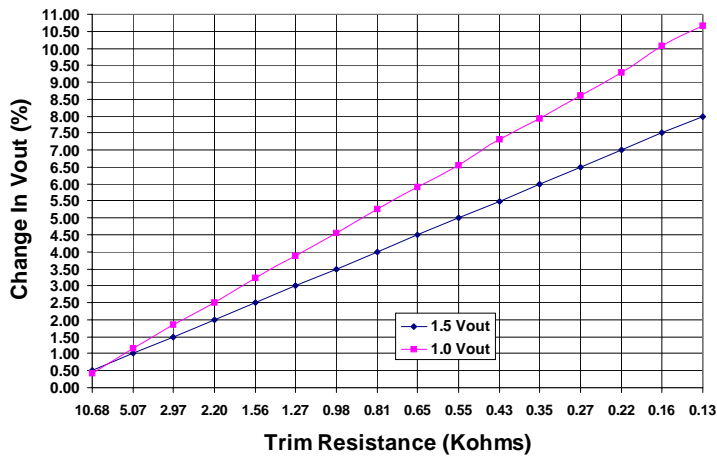

Turn On Time (V_{IN} to V_{OUT})

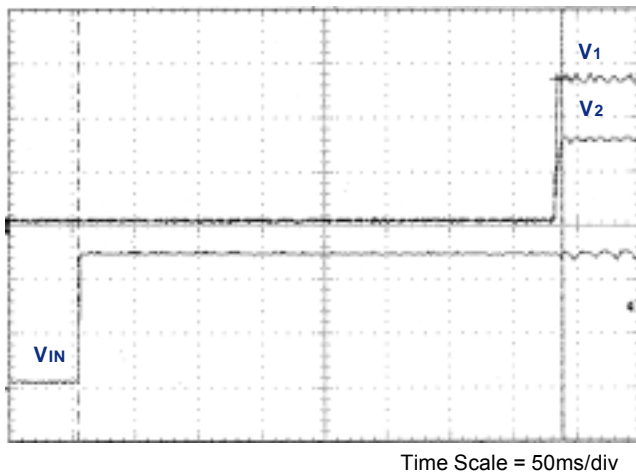

Rise Time (V₁ and V₂)

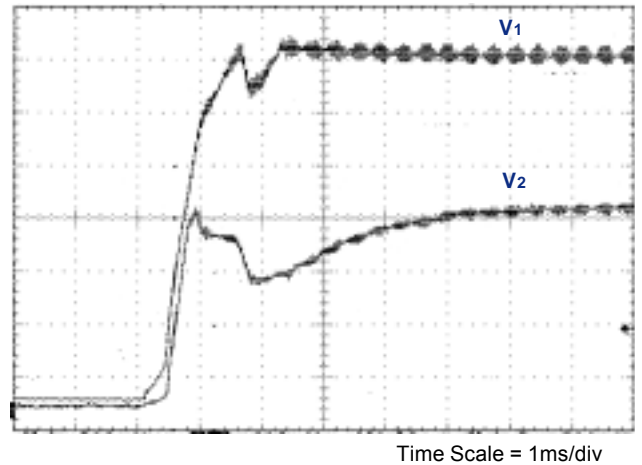

PERFORMANCE CURVES: WPA60R48D1510 and WPA60R48D1510-1

Turn Off Time (VIN to VOUT)

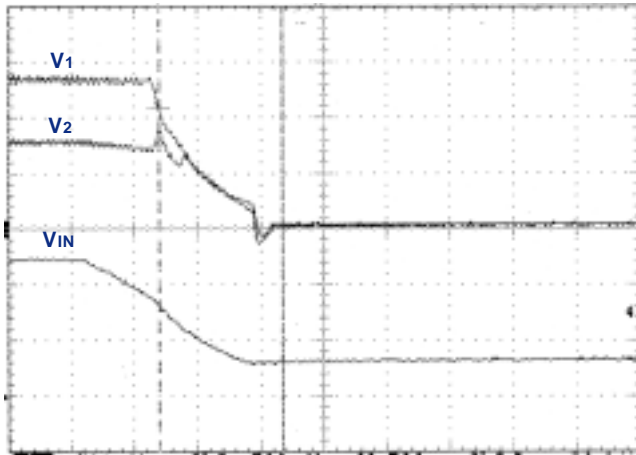

Time Scale = 500µs/div

Primary On Time (Primary Remote to VOUT)

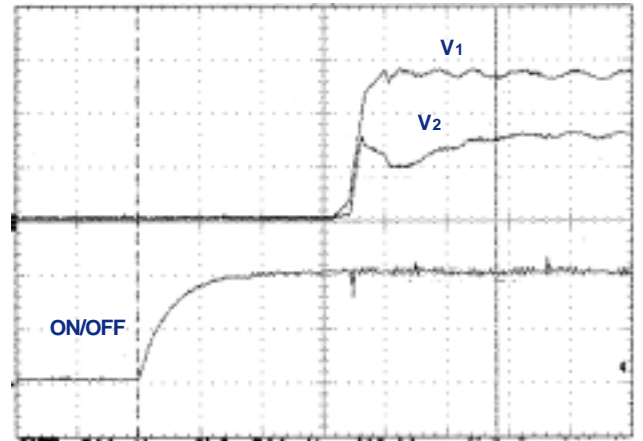

Time Scale = 2ms/div

**CH1 (1.5Vdc) Transient Response
50% to 100% Load Step**

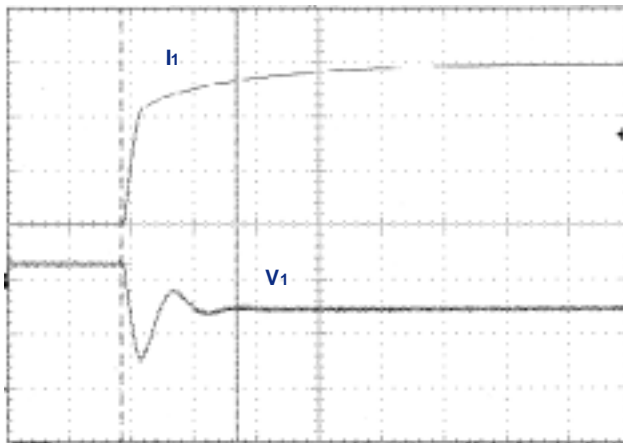

Voltage Scale = 100mV/div; Time Scale = 100µs/div
di/dt = 0.2A/µs

**CH1 (1.5Vdc) Transient Response
100% to 50% Load Step**

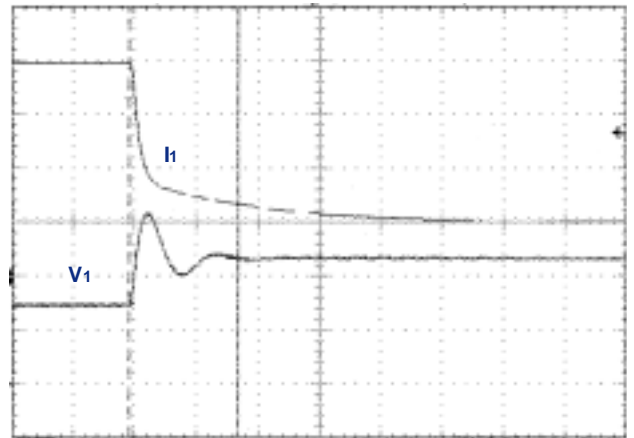

Voltage Scale = 100mV/div; Time Scale = 100µs/div
di/dt = 0.2A/µs

**CH2 (1.0Vdc) Transient Response
50% to 100% Load Step**

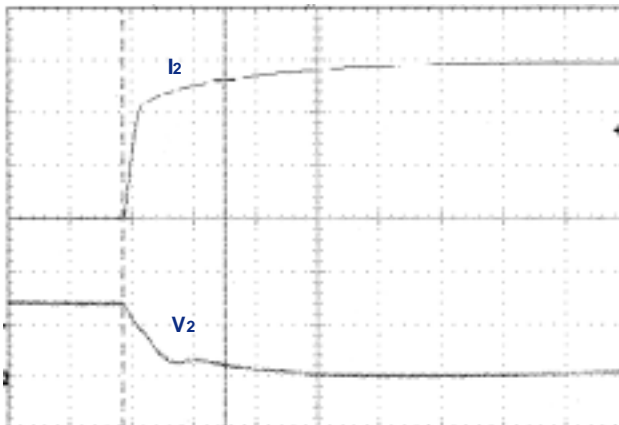

Voltage Scale = 50mV/div; Time Scale = 100µs/div
di/dt = 0.2A/µs

**CH2 (1.0Vdc) Transient Response
100% to 50% Load Step**

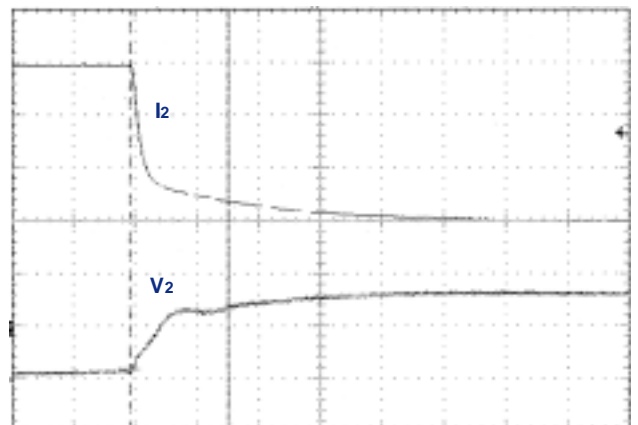

Voltage Scale = 50mV/div; Time Scale = 100µs/div
di/dt = 0.2A/µs

THERMAL DERATING CURVES

Thermal Derating (WPA60R48D0533)

Output Current v/s Temperature Vin = 48Vdc

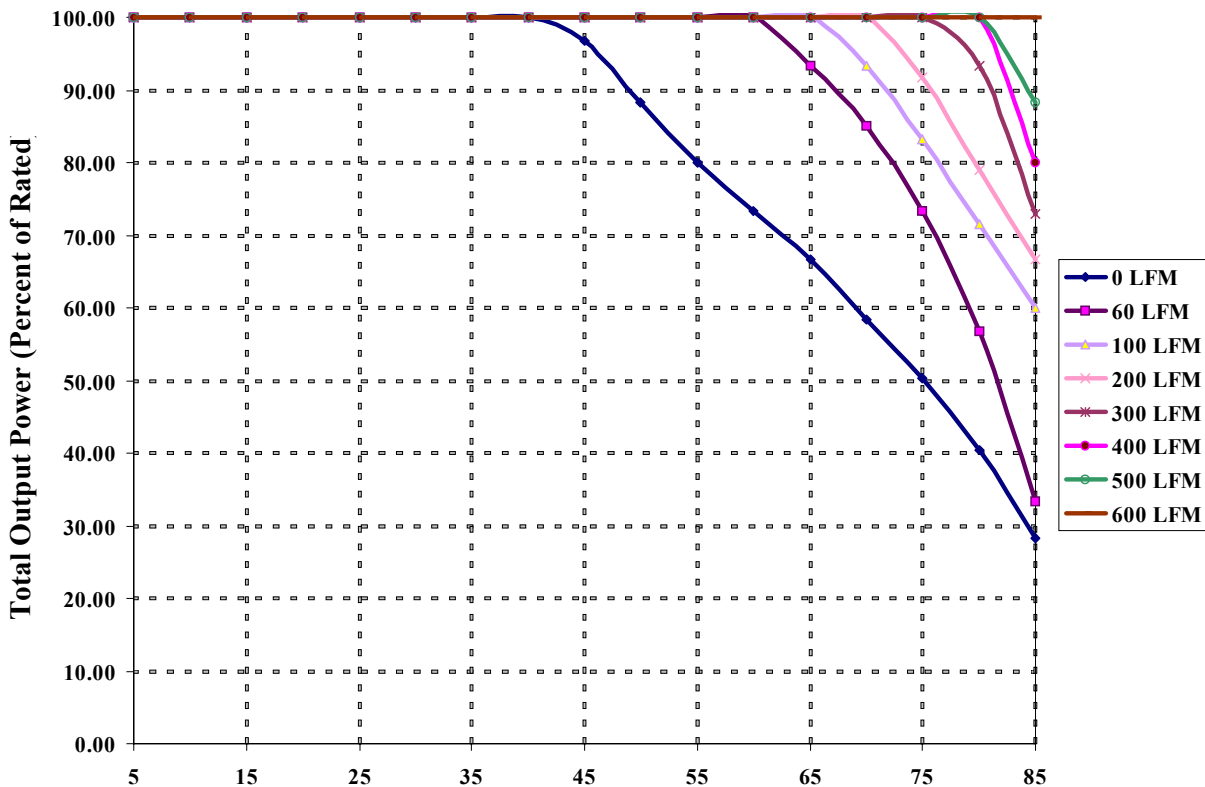

Output Current v/s Temperature Vin = 48Vdc

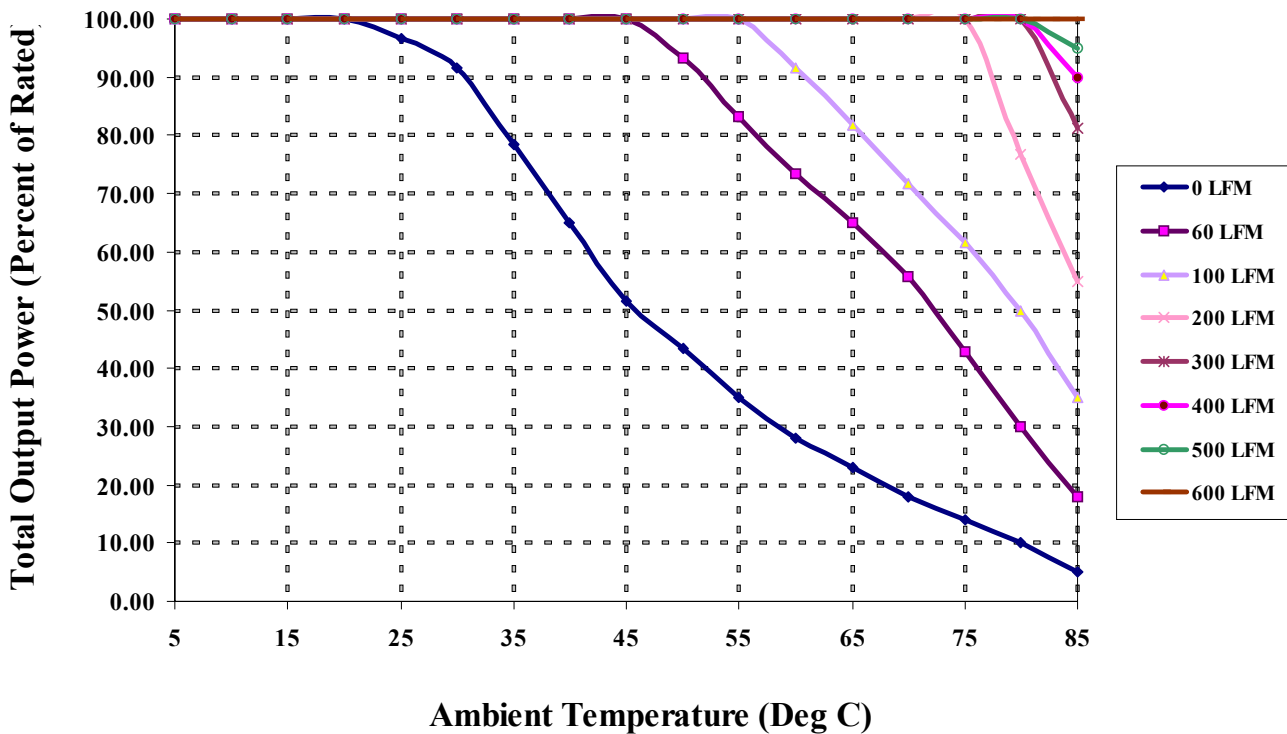

THERMAL DERATING CURVES

Thermal Derating (WPA60R48D3325)

Output Current v/s Temperature Vin = 48Vdc

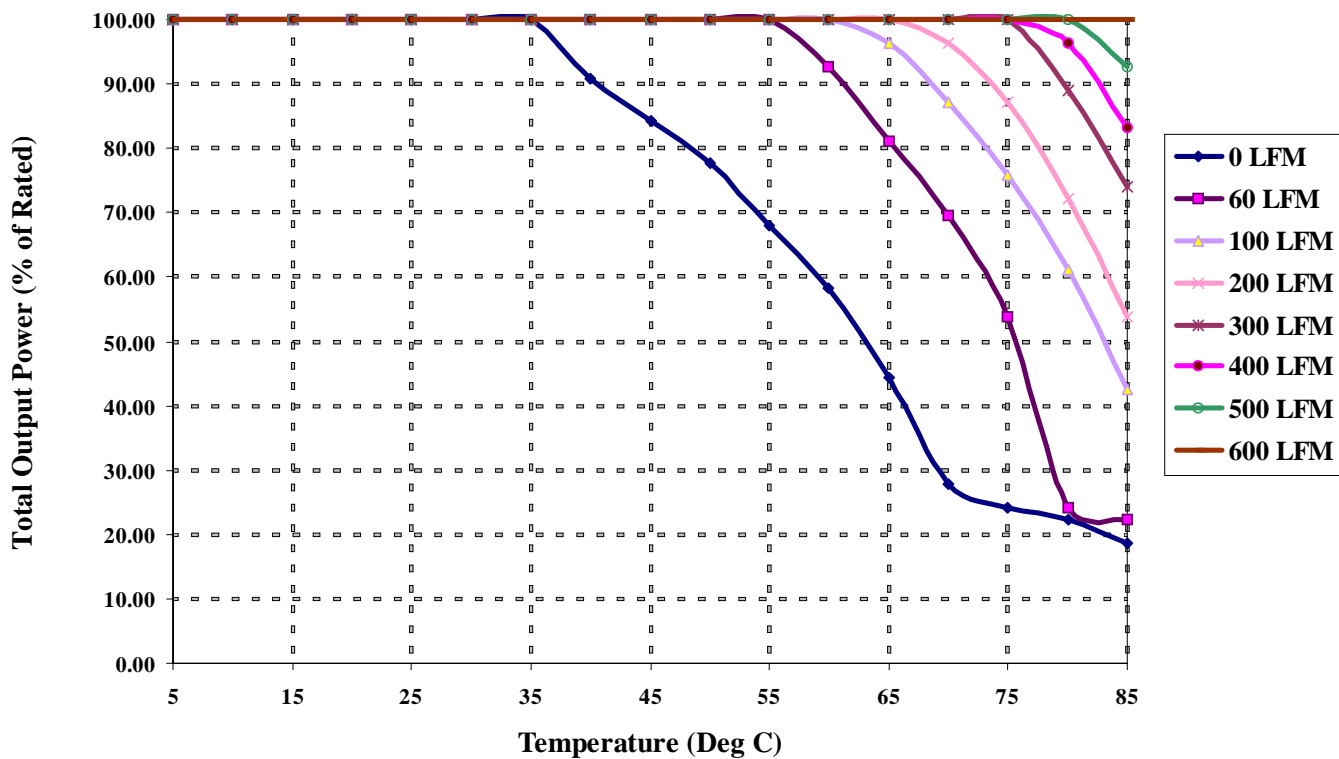

THERMAL DERATING CURVES

Thermal Derating (WPA60R48D3318)

Output Current v/s Temperature Vin = 48Vdc

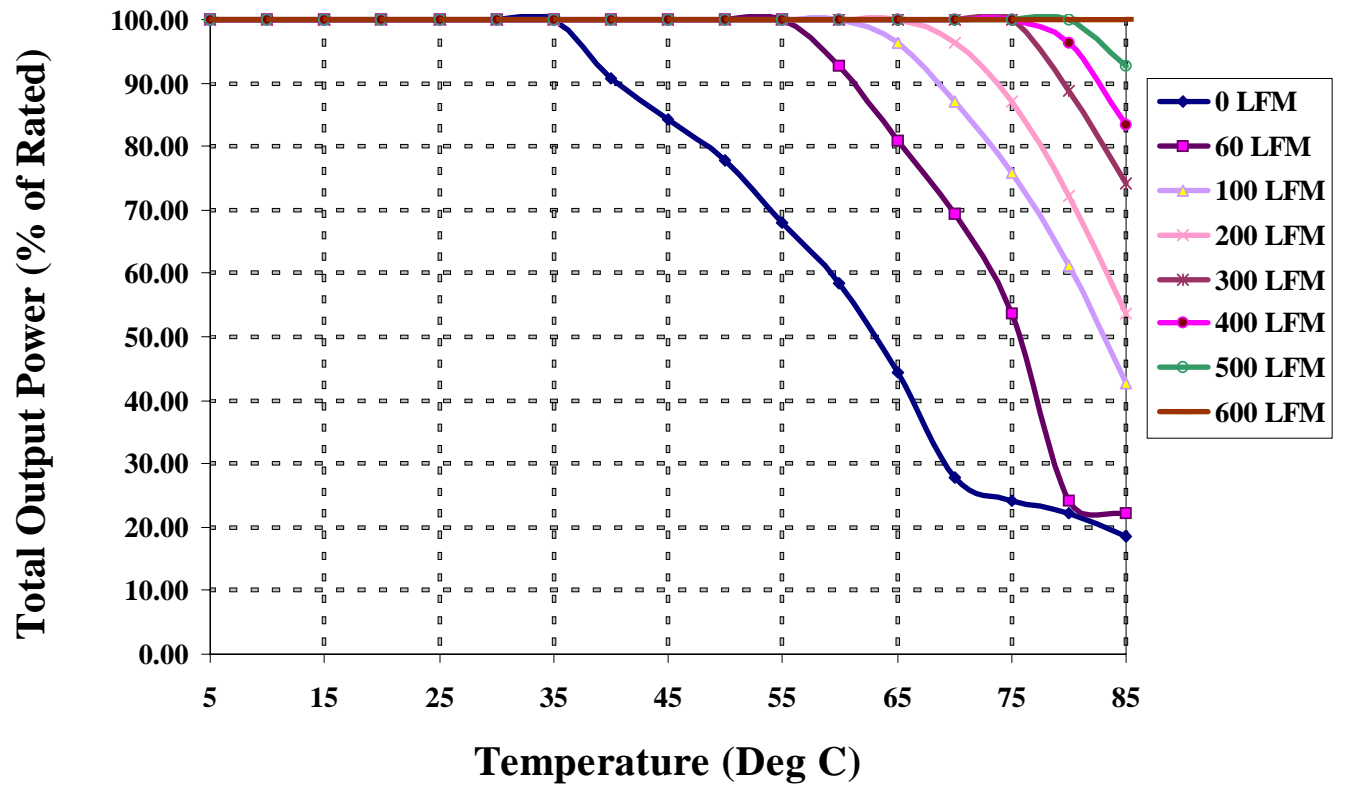

THERMAL DERATING CURVES

Thermal Derating (WPA60R48D3312)

Output Current v/s Temperature Vin = 48Vdc

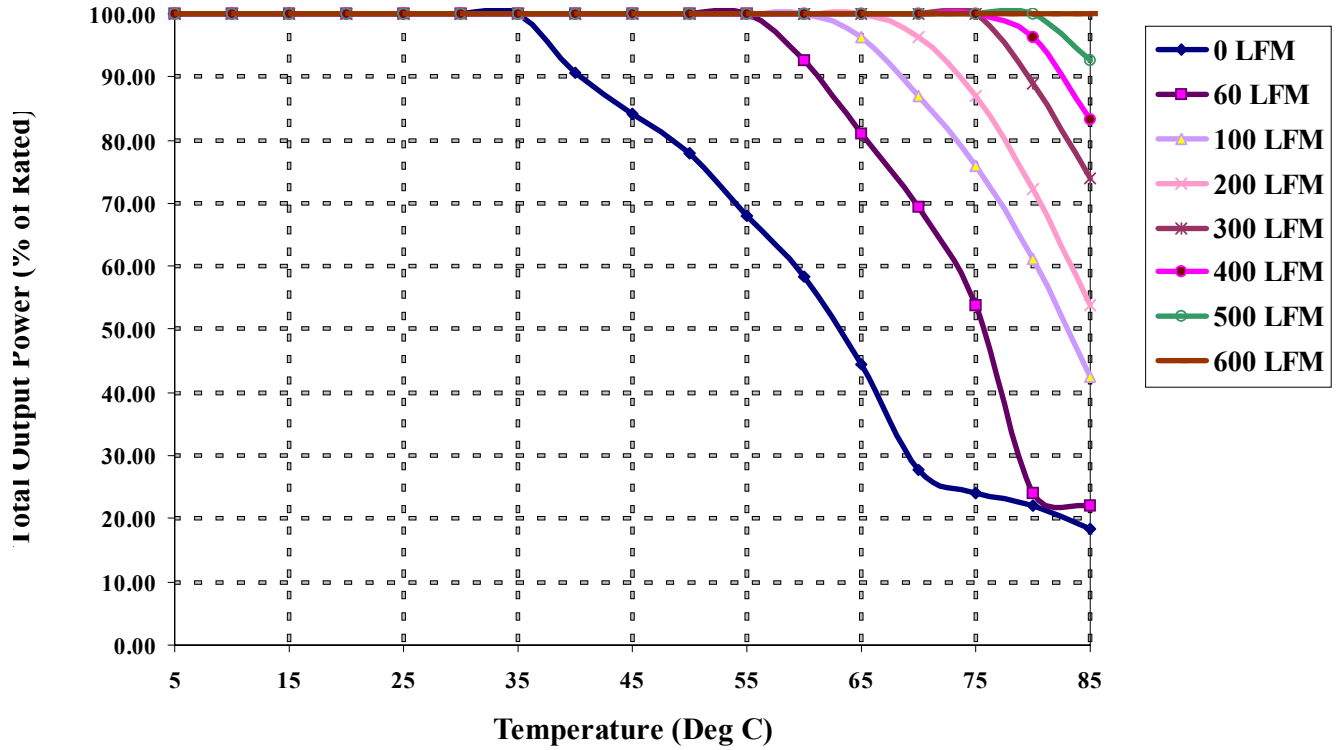

THERMAL DERATING CURVES

Thermal Derating (WPA60R48D2518)

Output Current v/s Temperature $V_{in} = 48V_{dc}$

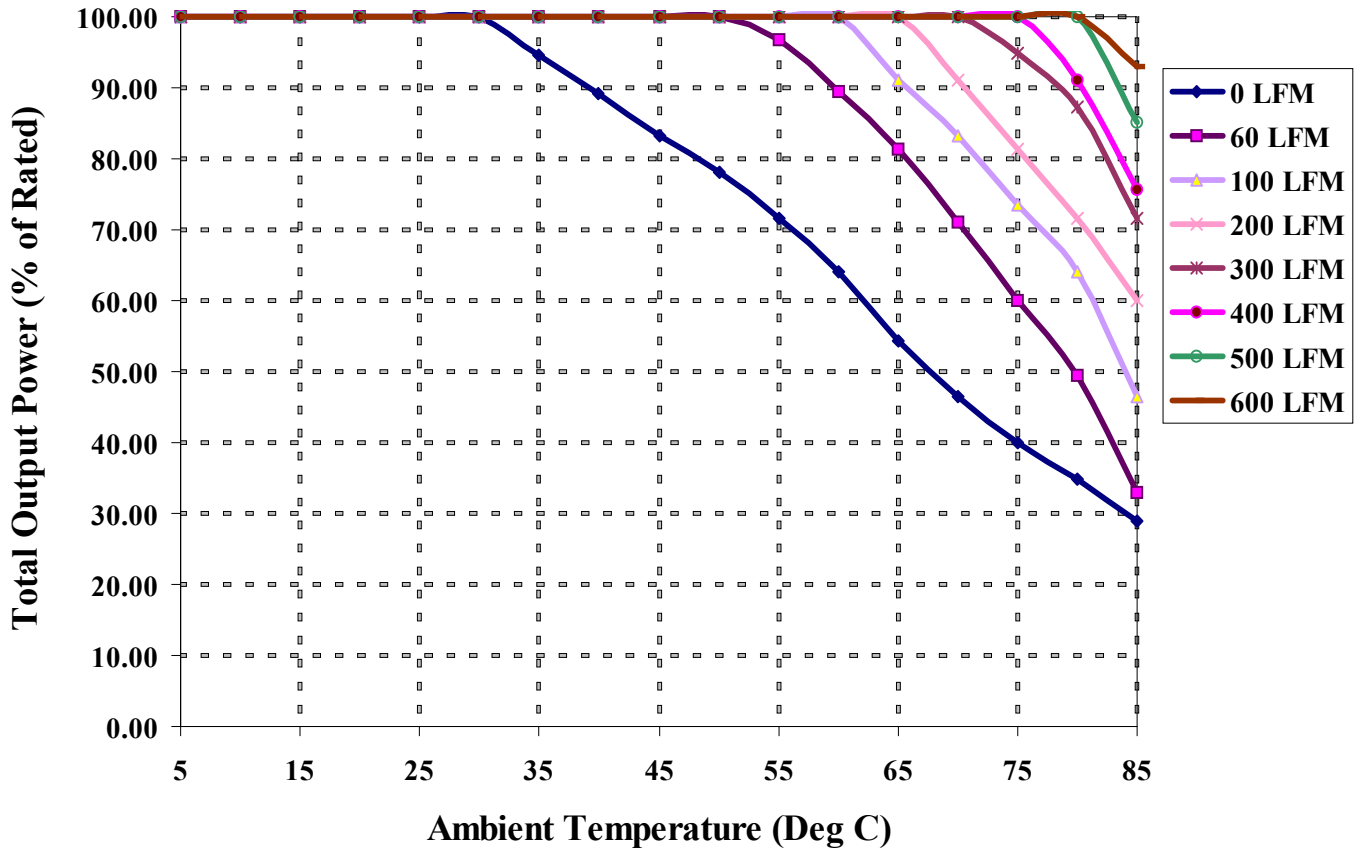

THERMAL DERATING CURVES

Thermal Derating (WPA60R48D2215)

Output Current v/s Temperature Vin = 48Vdc

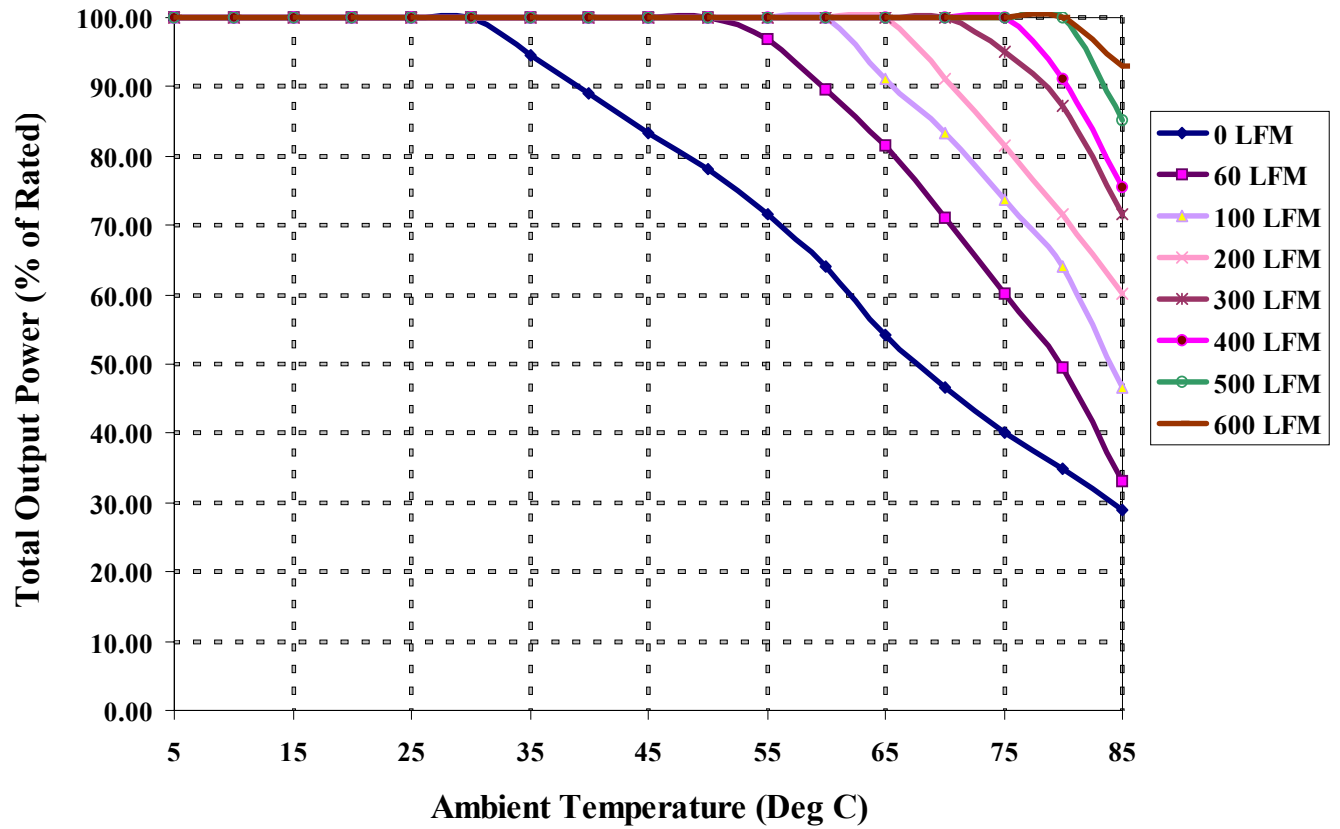

THERMAL DERATING CURVES

Thermal Derating (WPA60R48D1812)

Output Current v/s Temperature Vin = 48Vdc

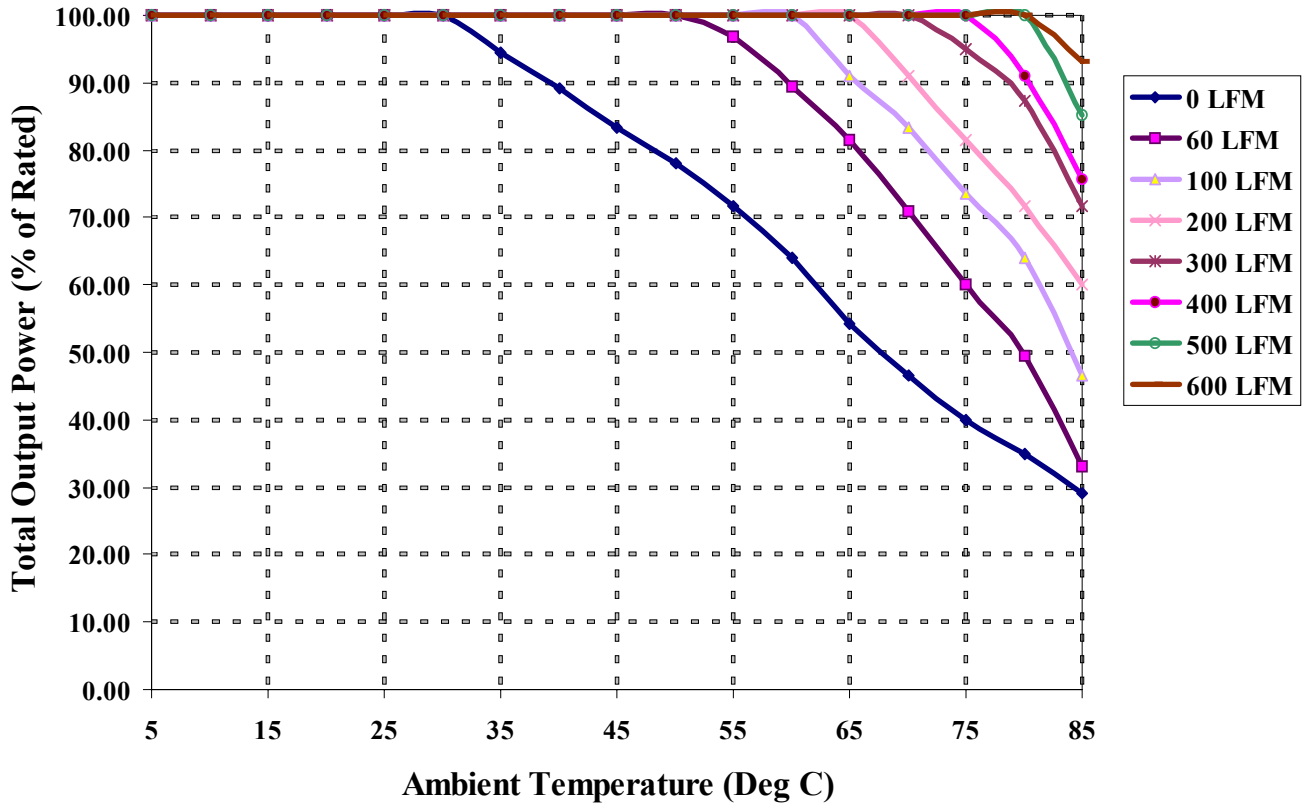

THERMAL DERATING CURVES

Thermal Derating (WPA60R48D1510)

Output Current v/s Temperature Vin = 48Vdc

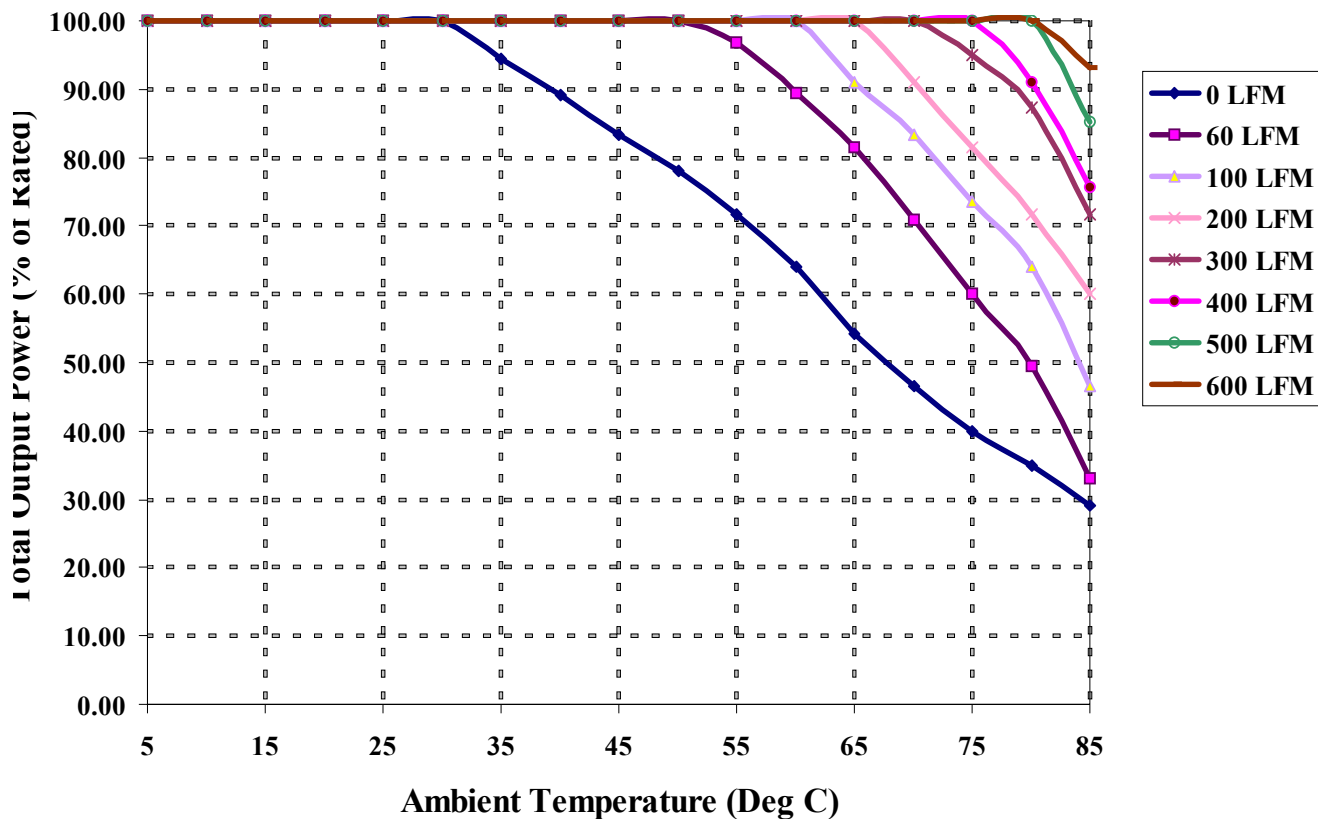

Power Electronics Division, Americas
 3400 E Britannia Drive, Tucson, Arizona 85706
 Tel: 800.547.2537 Fax: 520.295.4197

C&D Technologies, EMEA/Asia/Pacific
 Milton Keynes MK14 5BU UK
 Tel: +44 (0)1908 615232
 Fax: +44 (0)1908 617545

Any data, prices, descriptions or specifications presented herein are subject to revision by C&D Technologies, Inc. without notice. While such information is believed to be accurate as indicated herein, C&D Technologies, Inc. makes no warranty and hereby disclaims all warranties, express or implied, with regard to the accuracy or completeness of such information. Further, because the product(s) featured herein may be used under conditions beyond its control, C&D Technologies, Inc. hereby disclaims all warranties, either express or implied, concerning the fitness or suitability of such product(s) for any particular use or in any specific application or arising from any course of dealing or usage of trade. The user is solely responsible for determining the suitability of the product(s) featured herein for user's intended purpose and in user's specific application. C&D Technologies, Inc. does not warrant or recommend that any of its products be used in any life support or aviation or aerospace applications.